

Mobile Homes in Earthquakes

How to protect your home and family



Courtesy National Information Service for Earthquake Engineering, University of California, Berkeley.

Earthquakes threaten older mobile homes through collapse and fire

- Many older mobile homes rest on slender supports that overturn in earthquakes
- Collapse injures occupants & damages homes, contents, water heater, & utilities
- Collapse can render exits unsafe, especially for occupants fleeing a fire
- Fires spread faster between closely spaced dwellings. Narrow roads make fire department access harder.

Bracing can make a big difference



Mobile homes are

2 to 5
times more vulnerable than woodframe houses

In strong shaking,

95% of unbraced mobile homes can fall off their foundations, as in the 1994 Northridge earthquake.

In 3 mobile home parks in the Northridge earthquake,



1 in 7 mobile homes burned. Several ignitions were because of mobile home collapse.



Earthquakes much larger than **1989 and 1994** are inevitable and could happen any day.

How to protect your home and family

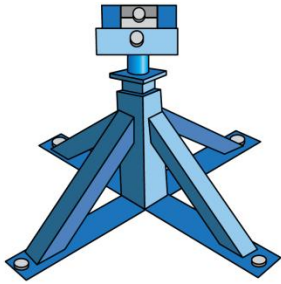
Reduce or prevent collapse



Good: Earthquake Resistant Bracing System (ERBS)
\$3,000-\$5,000

OR

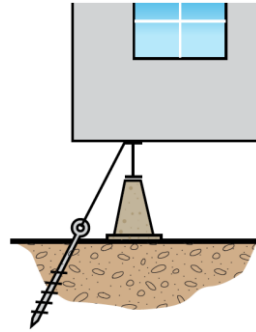

Better: Engineered Tie-down System (ETS)
\$1,000-\$2,000

OR

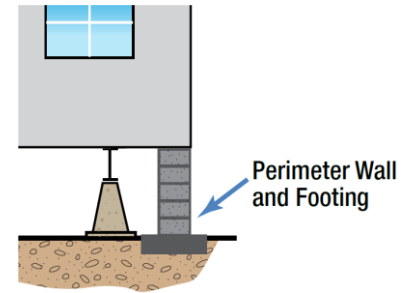

Best: Reinforced concrete or reinforced masonry foundation
\$5,000-\$50,000

Reduce or prevent fire

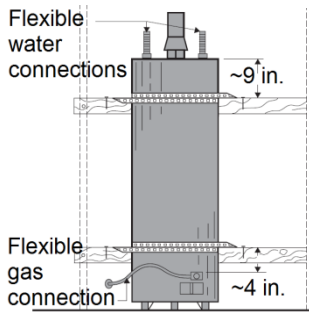

◀ Brace water heater (\$35-\$200)

AND

Flexible gas connection (\$100) ▶

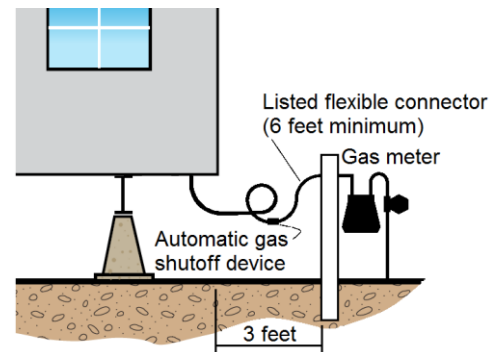

Ensure quality retrofit work

- Find the right contractor. For guidance, see <http://www.cslb.ca.gov/Consumers/HireAContractor/FindingTheRightContractor.asp>
- In California, consider a General Manufactured Housing Contractor. Check licenses at <https://www2.cslb.ca.gov/OnlineServices/CheckLicenses/CheckLicense.aspx>
- Check ERBS certification. In California, have the contractor show you the ERBS complies with CA Adm. Code, Title 25, Chapter 2, Art. 7.5.
- Get the work permitted and inspected. California enforcement agencies are listed at <https://ssw1.hcd.ca.gov/ParksListing/faces/parkslist/mp.jsp>
- Monitor your contractor's work as it is being done.

Other ways to reduce loss

- Practice Drop Cover and Hold On
- Put latches on cabinet doors
- Have water and food for at least 3 days, ideally 2 weeks
- Brace canopies and awnings
- Plan for emergencies with neighbors, <http://bit.ly/MobileHomePlanning>
- Consider earthquake insurance, www.earthquakeauthority.com
- Do one or more of these yearly.
- See www.shakeout.org for more info