

FIXTURE TYPE: \_\_\_\_\_

PROJECT NAME: \_\_\_\_\_

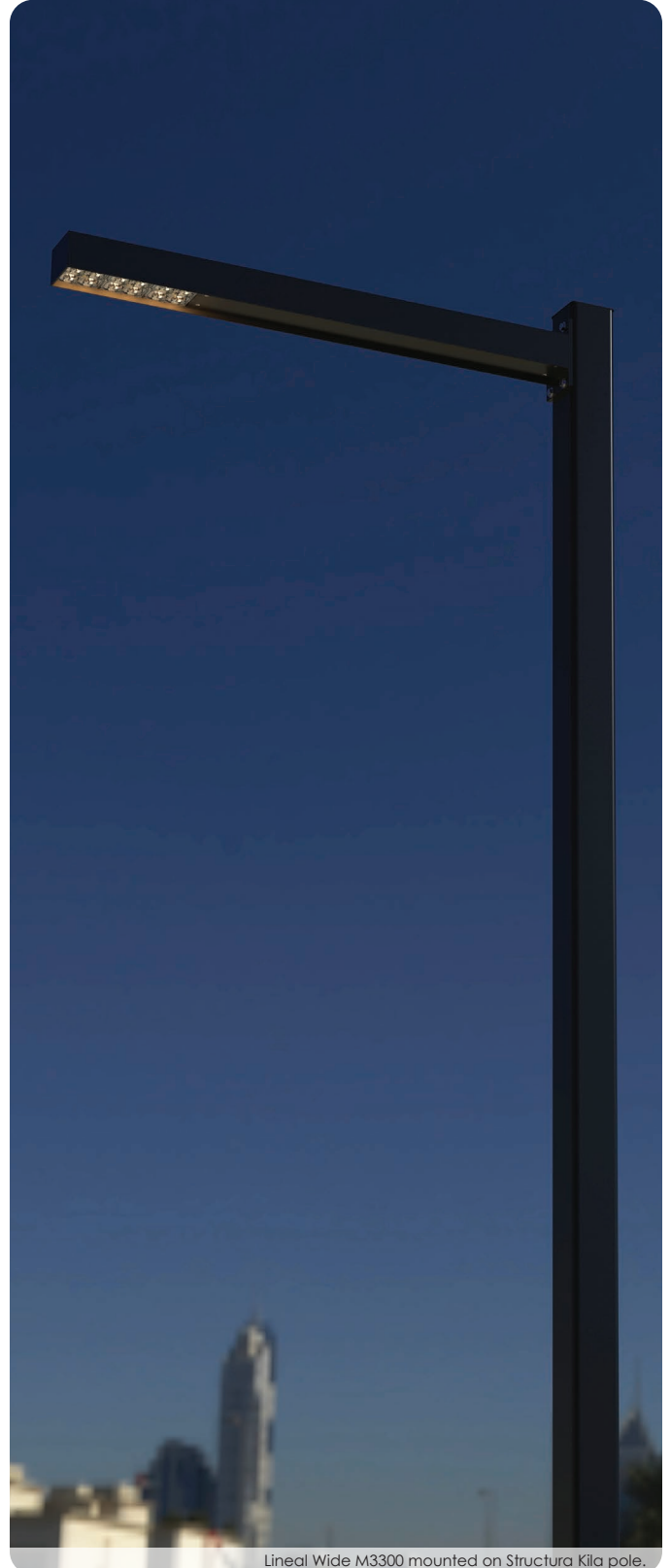

Lineal Wide M1100 mounted on Structura Spar pole.



Lineal Wide M3300 mounted on Structura Kila pole.

## SPECIFICATIONS:

**CONSTRUCTION:** Seamless aluminum housing comprised of 6005A-T61 extrusion and 6061-T6 end plates. Gasketed aluminum electrical access cover attached with captive stainless steel hardware and safety cable.

**ELECTRICAL:** Integral Class P, 120-277V or 347-480V, dimmable constant current driver. Luminaire is pre-wired with watertight 5 conductor 18 gauge SJEOOW whip. 10kA surge suppression is standard with optional external 20kA surge suppression. Operating temperature of -40°C to 50°C.

**OPTICAL SYSTEM:** LED boards have solderless connections for field upgradability. Available in CCT of 2700, 3000, 3500, and 4000K, >90 CRI. Optics are UV resistant molded PMMA in Type II and IV distributions. Consult factory for additional lumen output, CCT, and optical distribution options.

**CONTROLS:** Dimming through 0-10V input is standard. Available with integral motion sensor with photocell providing on/off and full light to dim control. Also available with wireless smart city control. See [SmartCity](#) control documentation for more information.

**FINISHES:** All exterior aluminum parts are polyester powder coat painted to meet AAMA 2604 standards. See Structura's finish options for available colors. [Care and Maintenance](#)

**LISTINGS & RATINGS:** Luminaire CSA listed according to CSA C22.2 No. 250.0-18/UL Standard 1598. Suitable for wet locations. LM-80 test reported L70 > 90,000 hours and calculated L70 > 110,000 hours. Bug rating: B1-U0-G1. IP65 rated.

**WARRANTY:** 5-year warranty on LED and drivers.



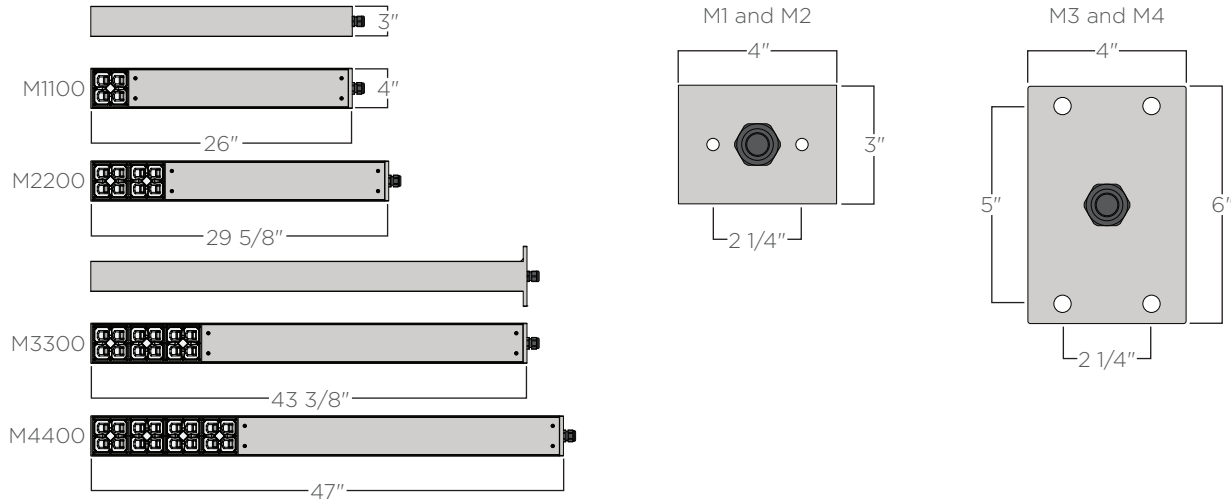

			2700K	3000K	3500K	4000K		
mA	Wattage	CRI	Lumen <sup>(1)</sup>	Lumen <sup>(1)</sup>	Lumen <sup>(1)</sup>	Lumen <sup>(1)</sup>	EPA	Weight
1000	40.4	>90	2695	2761	2872	2982	0.67ft <sup>2</sup>	10.0lbs.
2000	83.6	>90	5390	5523	5744	5965	0.76ft <sup>2</sup>	11.4lbs.
3000	124.0	>90	8085	8284	8615	8947	1.10ft <sup>2</sup>	16.7lbs.
4000	167.2	>90	10790	11045	11487	11929	1.19ft <sup>2</sup>	18.1lbs.

**ORDERING GUIDE:** EXAMPLE: LINW-M22000-L30-2-C5-UNV-SP-WC-MS/L3-STD



<b>1</b>	<b>Series</b>	<b>4</b>	<b>Distribution<sup>(2)</sup></b>	<b>7</b>	<b>Mounting</b>
LINW	Lineal Wide	2	Type II	SP	Structura Pole <sup>(4)</sup>
		4	Type IV	ST	Square steel pole by Structura <sup>(5)</sup>
<b>2</b>	<b>Output<sup>(2)</sup></b>			NA	Pole by Others
M1100	1000mA	<b>5</b>	<b>Metal Finish</b>	<b>8</b>	<b>Options</b>
M2200	2000mA	C*	See color options on finishes technical sheet	MS/L*	Motion Sensor/Photocell <sup>(6)</sup>
M3300	3000mA	CSM	Custom Color	WC	Wireless Control <sup>(7)</sup>
M4400	4000mA	<b>6</b>	<b>Voltage</b>	<b>9</b>	<b>Special</b>
<b>3</b>	<b>CCT<sup>(2)</sup></b>	UNV	120-277V	STD	Standard
L27	2700K <sup>(3)</sup>	HIGH	347-480V		
L30	3000K <sup>(3)</sup>				
L35	3500K				
L40	4000K				
AMB	Amber				

1. Lumen output based upon Type IV distribution.  
 2. Contact factory for alternative output, CCT, or distribution options.  
 3. CCT of 2700K or 3000K color temperature required for DarkSky Approved.  
 4. Structura pole specification sheet must be completed showing mounting locations and quantities as a separate item.  
 5. Specify steel pole on page 114 as a separate item.  
 6. Specify coverage pattern (see page 113 for detail). Requires wireless handheld configuration tool.  
 7. Synapse Wireless site gateway controller must be ordered separately. Please contact factory for design assistance.

## Lineal Wide standard wiring<sup>(1)</sup>

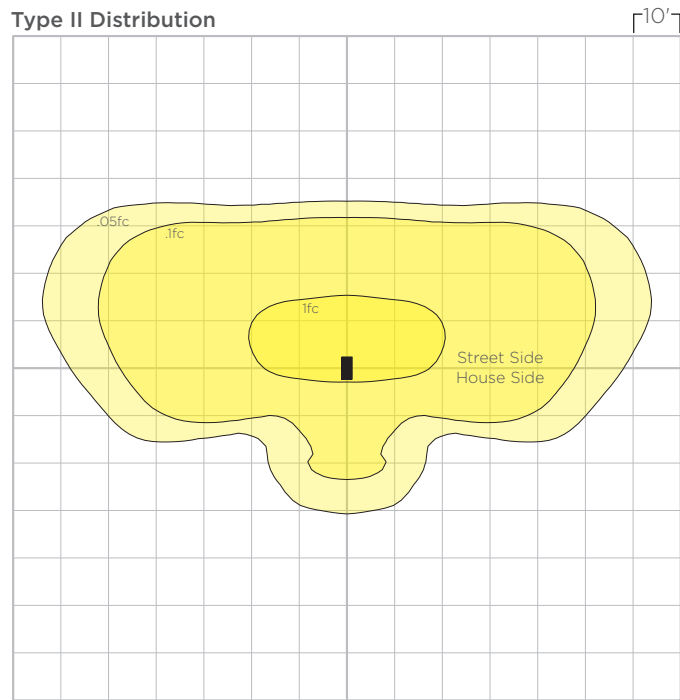
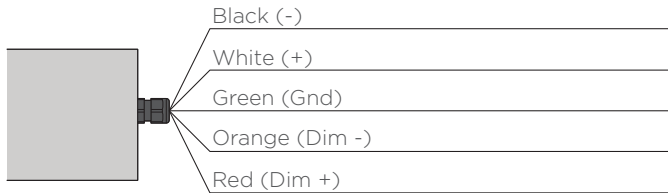

LINW-M1100-L27-2-C(X)-UNV-XX-STD mounted at 16'

[IES file download](#)

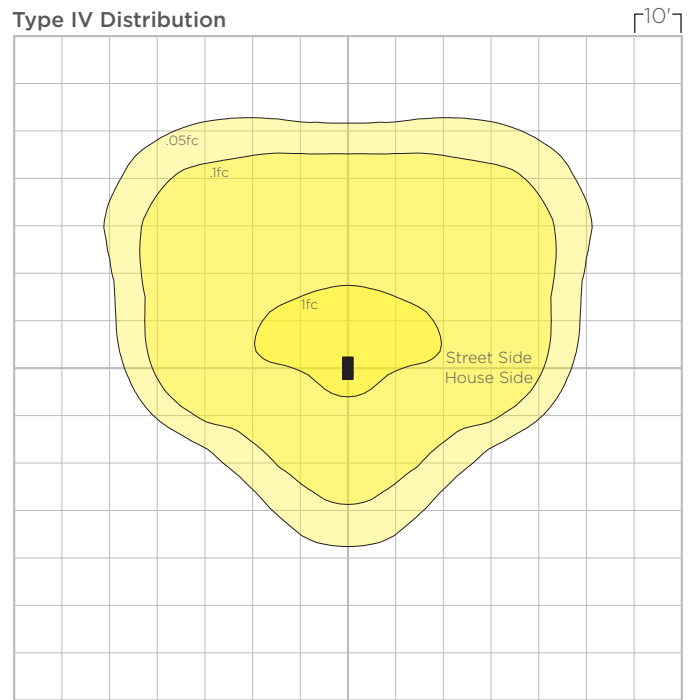

LINW-M1100-L27-4-C(X)-UNV-XX-STD mounted at 16'

1. All fixtures are provided with a 12" 18/5 SJEOOW whip. Cap dimming wires if dimming is not required.

**Motion Sensor Type L3 (ordering code MS/L3)**

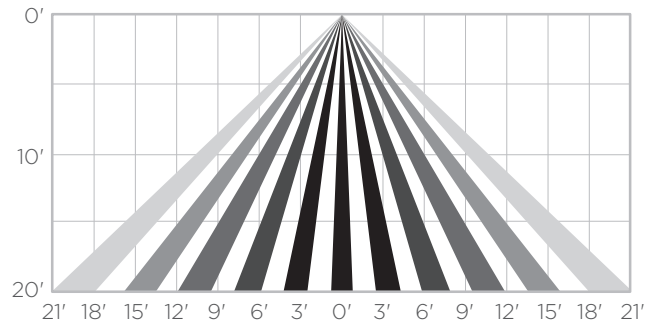
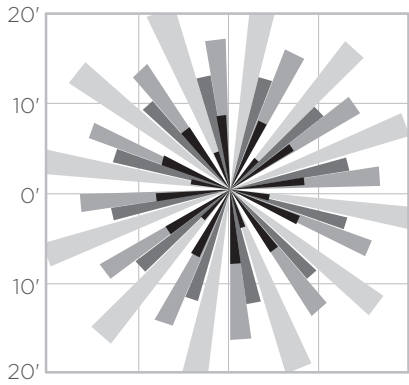

**Motion Sensor Type L7 (ordering code MS/L7)**

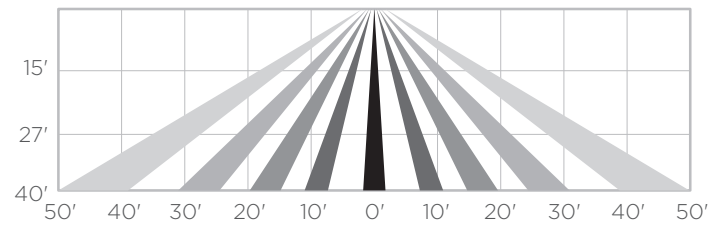
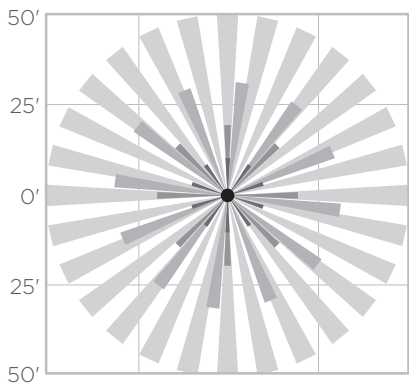

FIXTURE TYPE: \_\_\_\_\_

PROJECT NAME: \_\_\_\_\_

### FEATURES:

- Heights available from 10 to 40'
- Polyester powder coat painted (AAMA 2604 standard)
- Supplied with a two piece casted aluminum base cover
- Multiple mounting options

#### Fixture Orientation

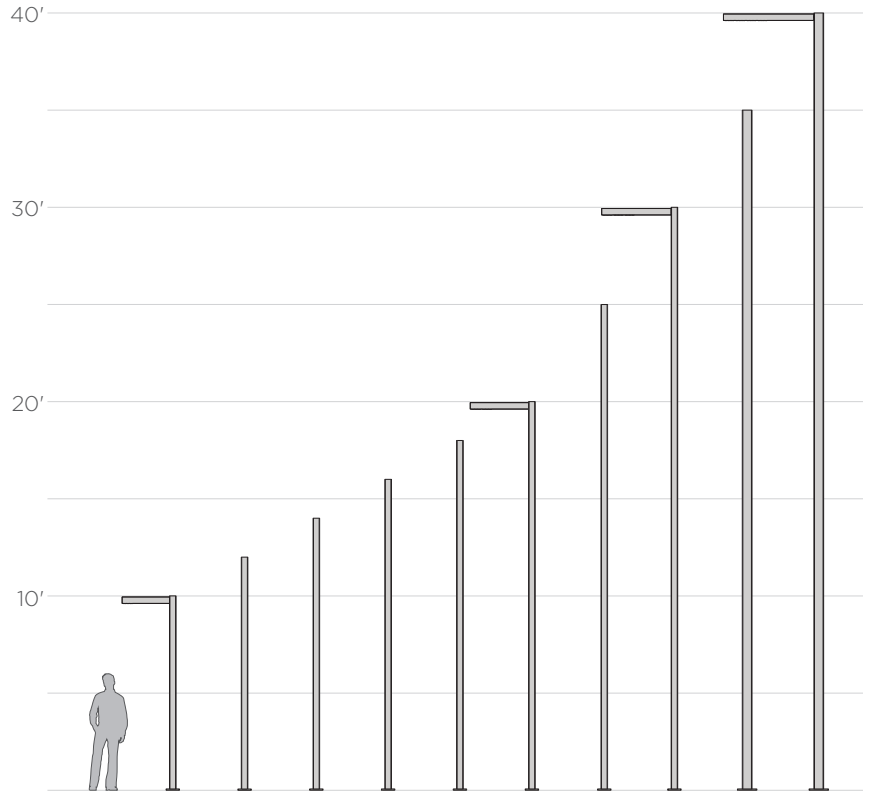
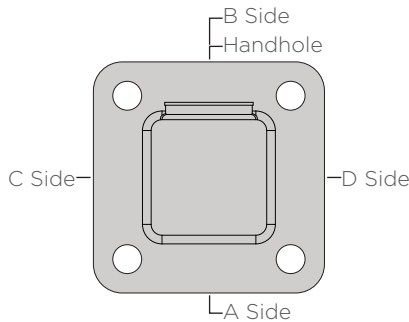

### ORDERING GUIDE: EXAMPLE: ST-20-4-5-C7-A20-B12-STD



<b>1</b>	<b>Series</b>
ST	Square Steel Pole
<b>2</b>	<b>Pole Height</b>
10 40 **	10' 40' Specify
<b>3</b>	<b>Pole Size</b>
4 5 6	4" 5" 6"
<b>4</b>	<b>Wall Thickness</b>
S T	Standard Thick

<b>5</b>	<b>Pole Finish</b>
****	See color options on finishes technical sheet Custom Color
<b>CSM</b>	
<b>6</b>	<b>A Side Fixture Mounting Height</b>
Blank A10 A12 A**	No fixture on this side 10' A Side 12' A Side Specify
<b>7</b>	<b>B Side Fixture Mounting Height</b>
Blank B**	No fixture on this side Specify

<b>8</b>	<b>C Side Fixture Mounting Height</b>
Blank C**	No fixture on this side Specify
<b>9</b>	<b>D Side Fixture Mounting Height</b>
Blank D**	No fixture on this side Specify
<b>10</b>	<b>Options</b>
BNR GALV GFCI VD	Banner <sup>(1)</sup> Galvanization <sup>(2)</sup> GFCI Box Vibration Dampener
<b>11</b>	<b>Special</b>
STD	Standard

1. Consult factory for allowable EPA for banners.  
2. Due to the nature of galvanization, some surface smoothness imperfections can be present.

FIXTURE TYPE: \_\_\_\_\_

PROJECT NAME: \_\_\_\_\_



Lineal Wide M1100 mounted on Structura Spar pole.



Lineal Wide M3300 mounted on Structura Kila pole.

## SPECIFICATIONS:

**CONSTRUCTION:** Seamless aluminum housing comprised of 6005A-T61 extrusion and 6061-T6 end plates. Gasketed aluminum electrical access cover attached with captive stainless steel hardware and safety cable.

**ELECTRICAL:** Integral Class P, 120-277V or 347-480V, dimmable constant current driver. Luminaire is pre-wired with watertight 5 conductor 18 gauge SJEOOW whip. 10kA surge suppression is standard with optional external 20kA surge suppression. Operating temperature of -40°C to 50°C.

**OPTICAL SYSTEM:** LED boards have solderless connections for field upgradability. Available in CCT of 2700, 3000, 3500, and 4000K, >90 CRI. Optics are UV resistant molded PMMA in Type II and IV distributions. Consult factory for additional lumen output, CCT, and optical distribution options.

**CONTROLS:** Dimming through 0-10V input is standard. Available with integral motion sensor with photocell providing on/off and full light to dim control. Also available with wireless smart city control. See [SmartCity](#) control documentation for more information.

**FINISHES:** All exterior aluminum parts are polyester powder coat painted to meet AAMA 2604 standards. See Structura's finish options for available colors. [Care and Maintenance](#)

**LISTINGS & RATINGS:** Luminaire CSA listed according to CSA C22.2 No. 250.0-18/UL Standard 1598. Suitable for wet locations. LM-80 test reported L70 > 90,000 hours and calculated L70 > 110,000 hours. Bug rating: B1-U0-G1. IP65 rated.

**WARRANTY:** 5-year warranty on LED and drivers.



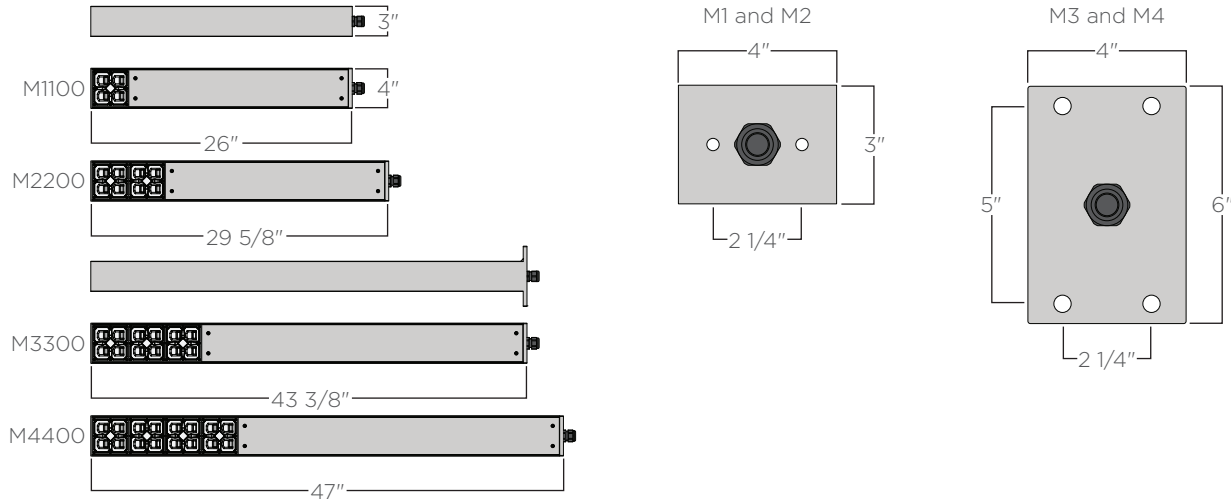

			2700K	3000K	3500K	4000K		
mA	Wattage	CRI	Lumen <sup>(1)</sup>	Lumen <sup>(1)</sup>	Lumen <sup>(1)</sup>	Lumen <sup>(1)</sup>	EPA	Weight
1000	40.4	>90	2695	2761	2872	2982	0.67ft <sup>2</sup>	10.0lbs.
2000	83.6	>90	5390	5523	5744	5965	0.76ft <sup>2</sup>	11.4lbs.
3000	124.0	>90	8085	8284	8615	8947	1.10ft <sup>2</sup>	16.7lbs.
4000	167.2	>90	10790	11045	11487	11929	1.19ft <sup>2</sup>	18.1lbs.

**ORDERING GUIDE:** EXAMPLE: LINW-M22000-L30-2-C5-UNV-SP-WC-MS/L3-STD



<b>1</b>	<b>Series</b>	<b>4</b>	<b>Distribution<sup>(2)</sup></b>	<b>7</b>	<b>Mounting</b>
LINW	Lineal Wide	2	Type II	SP	Structura Pole <sup>(4)</sup>
<b>2</b>	<b>Output<sup>(2)</sup></b>	4	Type IV	ST	Square steel pole by Structura <sup>(5)</sup>
M1100	1000mA	<b>5</b>	<b>Metal Finish</b>	NA	Pole by Others
M2200	2000mA	C*	See color options on finishes technical sheet	<b>8</b>	<b>Options</b>
M3300	3000mA	CSM	Custom Color	MS/L*	Motion Sensor/Photocell <sup>(6)</sup>
M4400	4000mA	<b>6</b>	<b>Voltage</b>	WC	Wireless Control <sup>(7)</sup>
<b>3</b>	<b>CCT<sup>(2)</sup></b>	UNV	120-277V	<b>9</b>	<b>Special</b>
L27	2700K <sup>(3)</sup>	HIGH	347-480V	STD	Standard
L30	3000K <sup>(3)</sup>				
L35	3500K				
L40	4000K				
AMB	Amber				

1. Lumen output based upon Type IV distribution.  
 2. Contact factory for alternative output, CCT, or distribution options.  
 3. CCT of 2700K or 3000K color temperature required for DarkSky Approved.  
 4. Structura pole specification sheet must be completed showing mounting locations and quantities as a separate item.  
 5. Specify steel pole on page 114 as a separate item.  
 6. Specify coverage pattern (see page 113 for detail). Requires wireless handheld configuration tool.  
 7. Synapse Wireless site gateway controller must be ordered separately. Please contact factory for design assistance.

## Lineal Wide standard wiring<sup>(1)</sup>

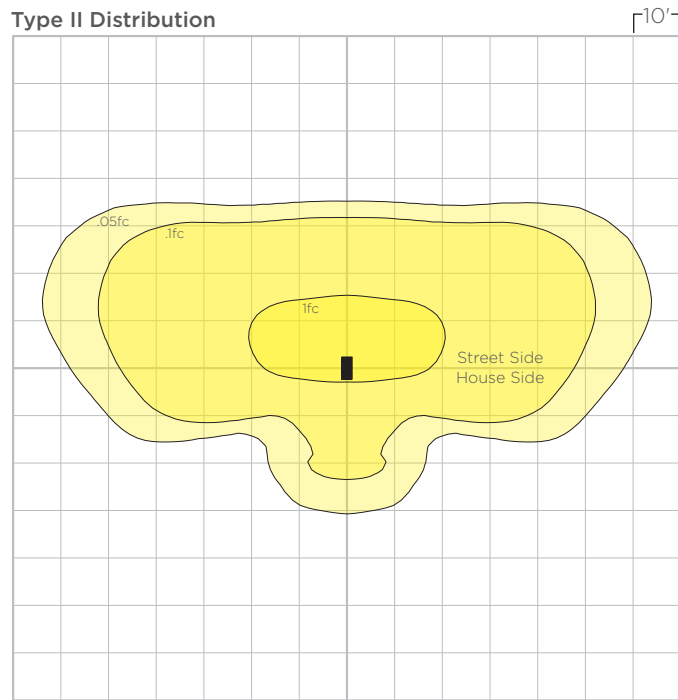
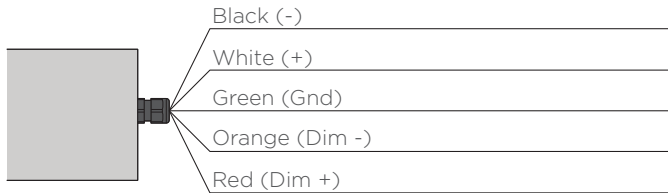

LINW-M1100-L27-2-C(X)-UNV-XX-STD mounted at 16'

[IES file download](#)

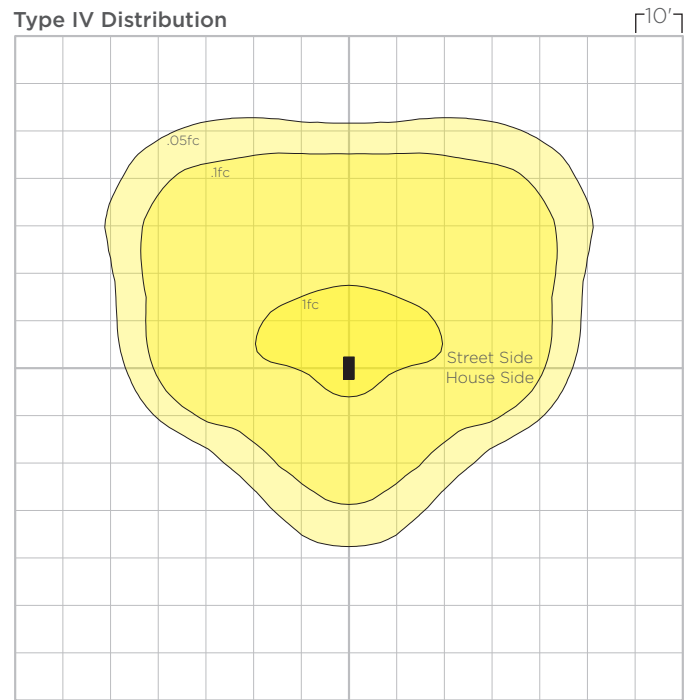

LINW-M1100-L27-4-C(X)-UNV-XX-STD mounted at 16'

1. All fixtures are provided with a 12" 18/5 SJEOOW whip. Cap dimming wires if dimming is not required.

**Motion Sensor Type L3 (ordering code MS/L3)**

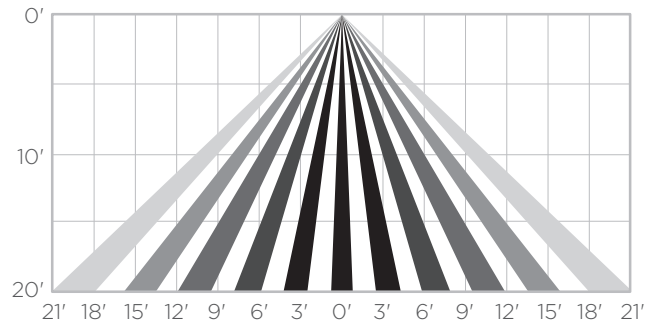
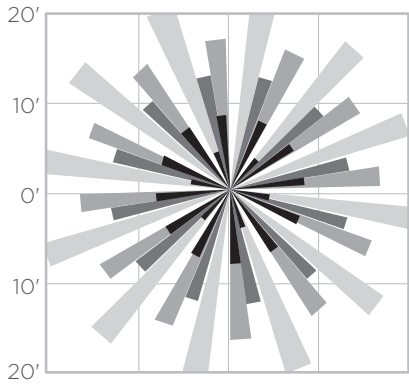

**Motion Sensor Type L7 (ordering code MS/L7)**

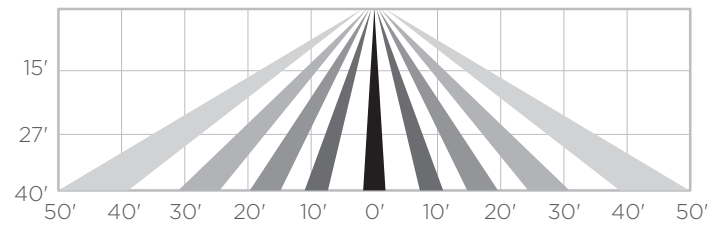
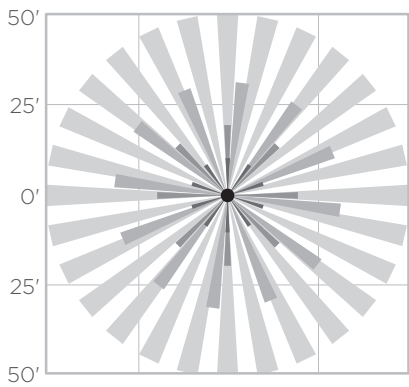

FIXTURE TYPE: \_\_\_\_\_

PROJECT NAME: \_\_\_\_\_

### FEATURES:

- Heights available from 10 to 40'
- Polyester powder coat painted (AAMA 2604 standard)
- Supplied with a two piece casted aluminum base cover
- Multiple mounting options

#### Fixture Orientation

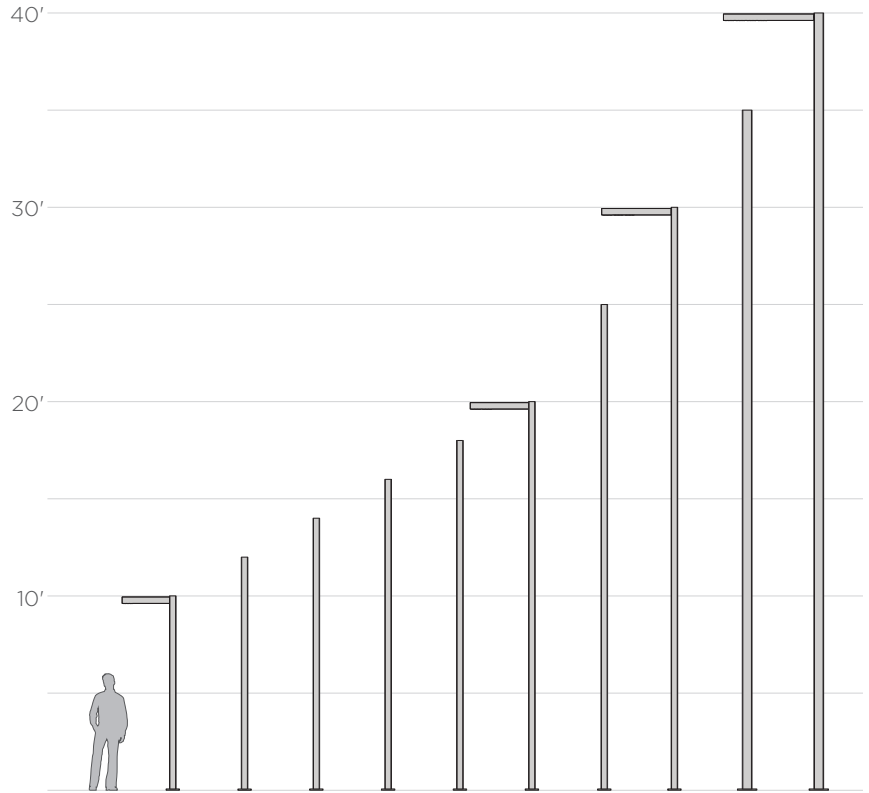
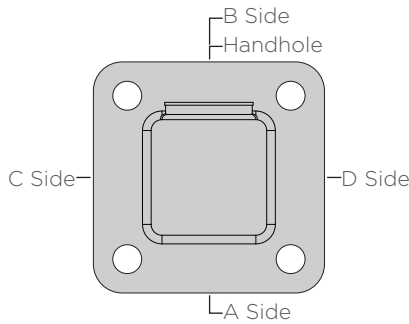

### ORDERING GUIDE: EXAMPLE: ST-20-4-5-C7-A20-B12-STD



<b>1</b>	<b>Series</b>
ST	Square Steel Pole
<b>2</b>	<b>Pole Height</b>
10 40 **	10' 40' Specify
<b>3</b>	<b>Pole Size</b>
4 5 6	4" 5" 6"
<b>4</b>	<b>Wall Thickness</b>
S T	Standard Thick

<b>5</b>	<b>Pole Finish</b>
****	See color options on finishes technical sheet Custom Color
<b>CSM</b>	
<b>6</b>	<b>A Side Fixture Mounting Height</b>
Blank A10 A12 A**	No fixture on this side 10' A Side 12' A Side Specify
<b>7</b>	<b>B Side Fixture Mounting Height</b>
Blank B**	No fixture on this side Specify

<b>8</b>	<b>C Side Fixture Mounting Height</b>
Blank C**	No fixture on this side Specify
<b>9</b>	<b>D Side Fixture Mounting Height</b>
Blank D**	No fixture on this side Specify
<b>10</b>	<b>Options</b>
BNR GALV GFCI VD	Banner <sup>(1)</sup> Galvanization <sup>(2)</sup> GFCI Box Vibration Dampener
<b>11</b>	<b>Special</b>
STD	Standard

1. Consult factory for allowable EPA for banners.  
2. Due to the nature of galvanization, some surface smoothness imperfections can be present.

FIXTURE TYPE: \_\_\_\_\_

PROJECT NAME: \_\_\_\_\_



Lineal Wide M1100 mounted on Structura Spar pole.

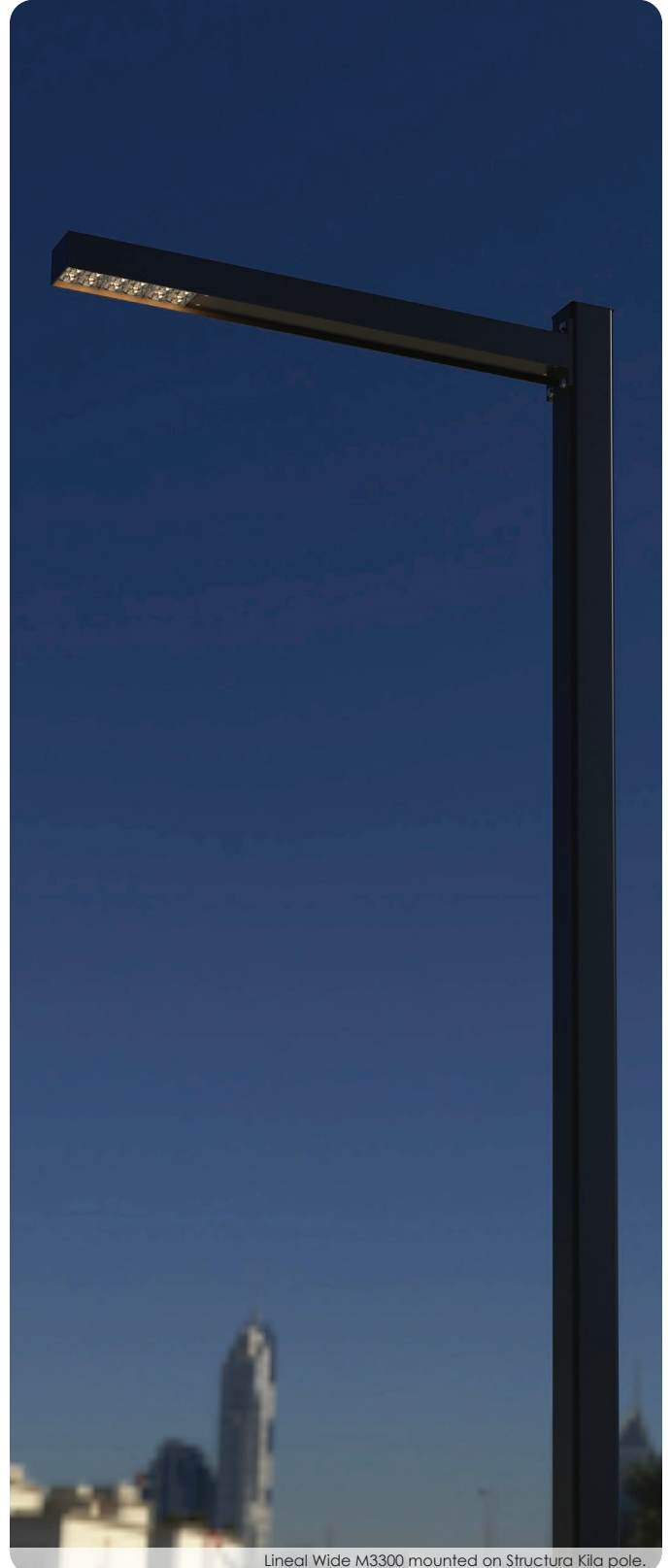

Lineal Wide M3300 mounted on Structura Kila pole.

## SPECIFICATIONS:

**CONSTRUCTION:** Seamless aluminum housing comprised of 6005A-T61 extrusion and 6061-T6 end plates. Gasketed aluminum electrical access cover attached with captive stainless steel hardware and safety cable.

**ELECTRICAL:** Integral Class P, 120-277V or 347-480V, dimmable constant current driver. Luminaire is pre-wired with watertight 5 conductor 18 gauge SJEOOW whip. 10kA surge suppression is standard with optional external 20kA surge suppression. Operating temperature of -40°C to 50°C.

**OPTICAL SYSTEM:** LED boards have solderless connections for field upgradability. Available in CCT of 2700, 3000, 3500, and 4000K, >90 CRI. Optics are UV resistant molded PMMA in Type II and IV distributions. Consult factory for additional lumen output, CCT, and optical distribution options.

**CONTROLS:** Dimming through 0-10V input is standard. Available with integral motion sensor with photocell providing on/off and full light to dim control. Also available with wireless smart city control. See [SmartCity](#) control documentation for more information.

**FINISHES:** All exterior aluminum parts are polyester powder coat painted to meet AAMA 2604 standards. See Structura's finish options for available colors. [Care and Maintenance](#)

**LISTINGS & RATINGS:** Luminaire CSA listed according to CSA C22.2 No. 250.0-18/UL Standard 1598. Suitable for wet locations. LM-80 test reported L70 > 90,000 hours and calculated L70 > 110,000 hours. Bug rating: B1-U0-G1. IP65 rated.

**WARRANTY:** 5-year warranty on LED and drivers.



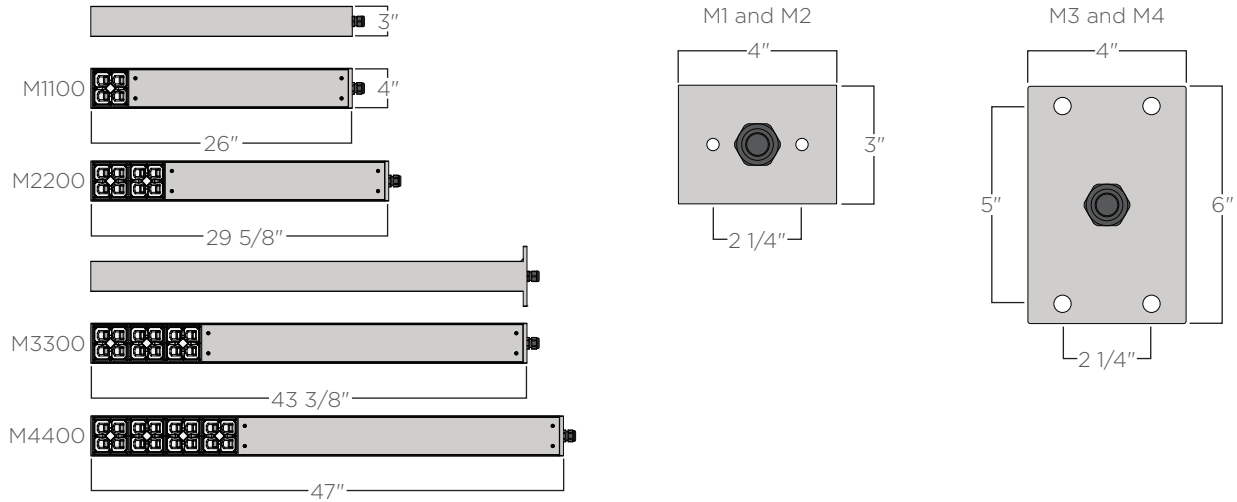

			2700K	3000K	3500K	4000K		
mA	Wattage	CRI	Lumen <sup>(1)</sup>	Lumen <sup>(1)</sup>	Lumen <sup>(1)</sup>	Lumen <sup>(1)</sup>	EPA	Weight
1000	40.4	>90	2695	2761	2872	2982	0.67ft <sup>2</sup>	10.0lbs.
2000	83.6	>90	5390	5523	5744	5965	0.76ft <sup>2</sup>	11.4lbs.
3000	124.0	>90	8085	8284	8615	8947	1.10ft <sup>2</sup>	16.7lbs.
4000	167.2	>90	10790	11045	11487	11929	1.19ft <sup>2</sup>	18.1lbs.

**ORDERING GUIDE:** EXAMPLE: LINW-M22000-L30-2-C5-UNV-SP-WC-MS/L3-STD



<b>1</b>	<b>Series</b>	<b>4</b>	<b>Distribution<sup>(2)</sup></b>	<b>7</b>	<b>Mounting</b>
LINW	Lineal Wide	2	Type II	SP	Structura Pole <sup>(4)</sup>
<b>2</b>	<b>Output<sup>(2)</sup></b>	4	Type IV	ST	Square steel pole by Structura <sup>(5)</sup>
M1100	1000mA	<b>5</b>	<b>Metal Finish</b>	NA	Pole by Others
M2200	2000mA	C*	See color options on finishes technical sheet	<b>8</b>	<b>Options</b>
M3300	3000mA	CSM	Custom Color	MS/L*	Motion Sensor/Photocell <sup>(6)</sup>
M4400	4000mA	<b>6</b>	<b>Voltage</b>	WC	Wireless Control <sup>(7)</sup>
<b>3</b>	<b>CCT<sup>(2)</sup></b>	UNV	120-277V	<b>9</b>	<b>Special</b>
L27	2700K <sup>(3)</sup>	HIGH	347-480V	STD	Standard
L30	3000K <sup>(3)</sup>				
L35	3500K				
L40	4000K				
AMB	Amber				

1. Lumen output based upon Type IV distribution.  
 2. Contact factory for alternative output, CCT, or distribution options.  
 3. CCT of 2700K or 3000K color temperature required for DarkSky Approved.  
 4. Structura pole specification sheet must be completed showing mounting locations and quantities as a separate item.  
 5. Specify steel pole on page 114 as a separate item.  
 6. Specify coverage pattern (see page 113 for detail). Requires wireless handheld configuration tool.  
 7. Synapse Wireless site gateway controller must be ordered separately. Please contact factory for design assistance.

## Lineal Wide standard wiring<sup>(1)</sup>

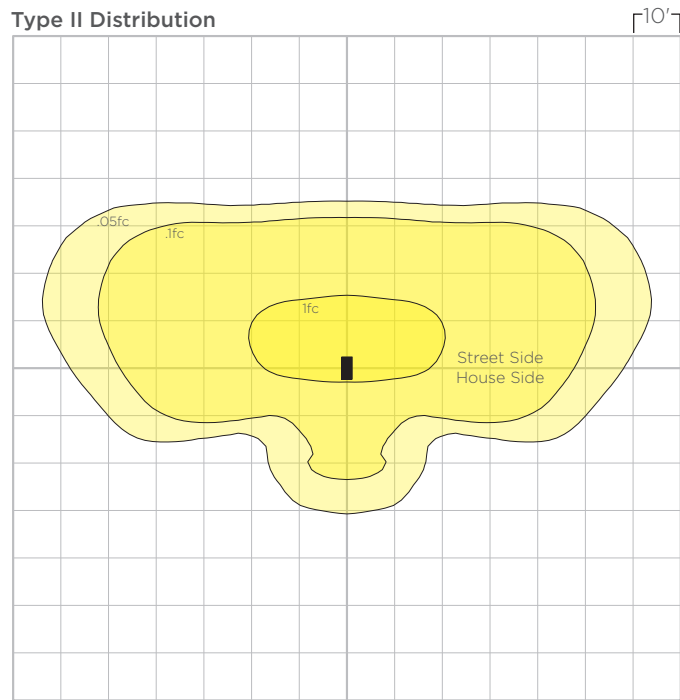
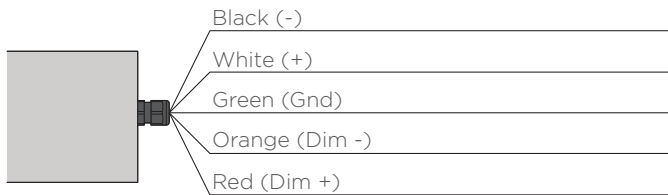

LINW-M1100-L27-2-C(X)-UNV-XX-STD mounted at 16'

[IES file download](#)

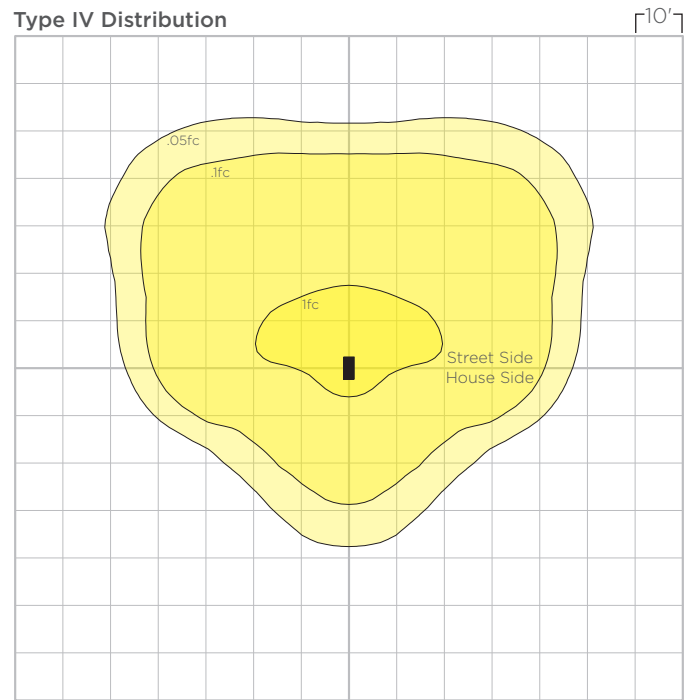

LINW-M1100-L27-4-C(X)-UNV-XX-STD mounted at 16'

1. All fixtures are provided with a 12" 18/5 SJEOOW whip. Cap dimming wires if dimming is not required.

**Motion Sensor Type L3 (ordering code MS/L3)**

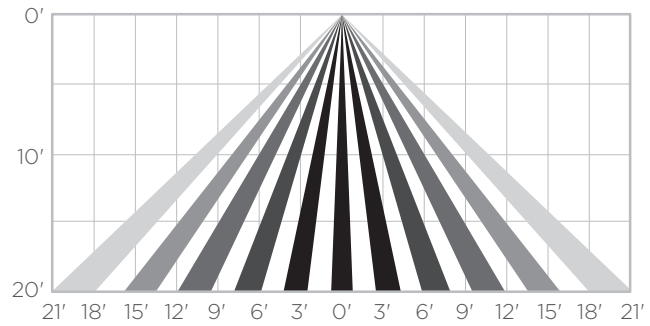
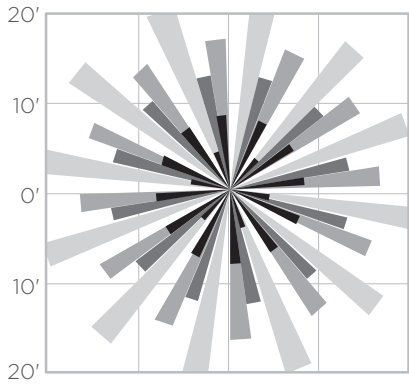

**Motion Sensor Type L7 (ordering code MS/L7)**

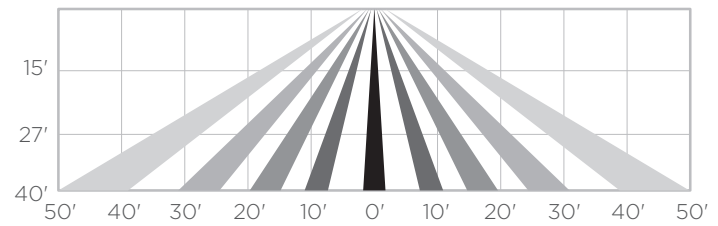
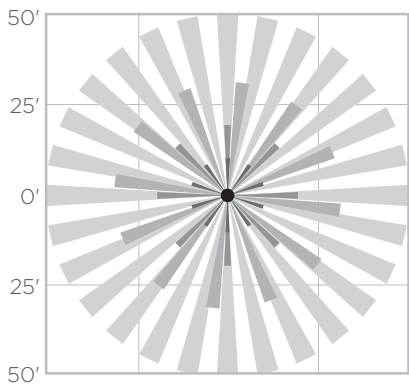

FIXTURE TYPE: \_\_\_\_\_

PROJECT NAME: \_\_\_\_\_

### FEATURES:

- Heights available from 10 to 40'
- Polyester powder coat painted (AAMA 2604 standard)
- Supplied with a two piece casted aluminum base cover
- Multiple mounting options

#### Fixture Orientation

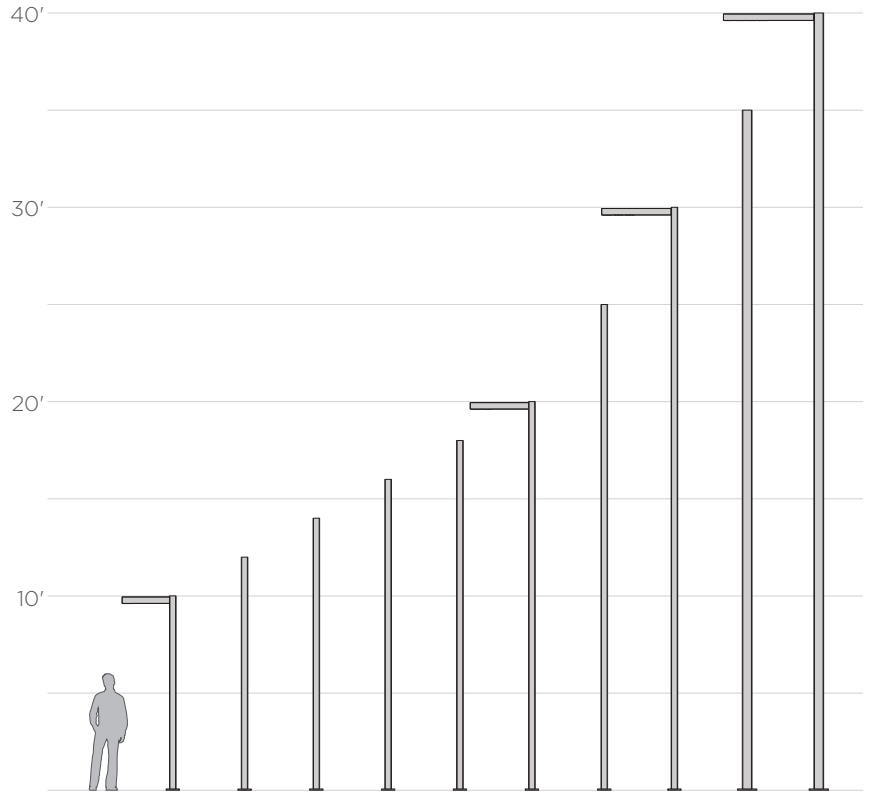
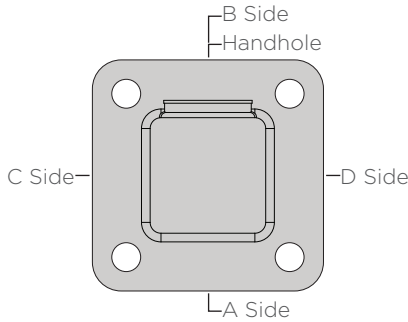

### ORDERING GUIDE: EXAMPLE: ST-20-4-5-C7-A20-B12-STD

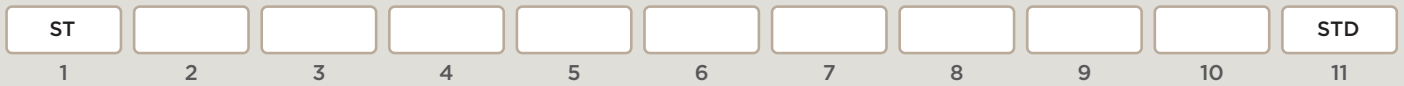

<b>1</b>	<b>Series</b>
ST	Square Steel Pole
<b>2</b>	<b>Pole Height</b>
10 40 **	10' 40' Specify
<b>3</b>	<b>Pole Size</b>
4 5 6	4" 5" 6"
<b>4</b>	<b>Wall Thickness</b>
S T	Standard Thick

<b>5</b>	<b>Pole Finish</b>
****	See color options on finishes technical sheet Custom Color
<b>CSM</b>	
<b>6</b>	<b>A Side Fixture Mounting Height</b>
Blank A10 A12 A**	No fixture on this side 10' A Side 12' A Side Specify
<b>7</b>	<b>B Side Fixture Mounting Height</b>
Blank B**	No fixture on this side Specify

<b>8</b>	<b>C Side Fixture Mounting Height</b>
Blank C**	No fixture on this side Specify
<b>9</b>	<b>D Side Fixture Mounting Height</b>
Blank D**	No fixture on this side Specify
<b>10</b>	<b>Options</b>
BNR GALV GFCI VD	Banner <sup>(1)</sup> Galvanization <sup>(2)</sup> GFCI Box Vibration Dampener
<b>11</b>	<b>Special</b>
STD	Standard

1. Consult factory for allowable EPA for banners.  
2. Due to the nature of galvanization, some surface smoothness imperfections can be present.

FIXTURE TYPE: \_\_\_\_\_

PROJECT NAME: \_\_\_\_\_



High performance slender aluminum bollard with accent panel and configuration options.

### FEATURES:

- Small 4" x 3" footprint
- Available with wood or aluminum front accent panel
- Multiple distribution options
- Concealed mounting hardware

### SPECIFICATIONS:

**CONSTRUCTION:** Seamless aluminum housing comprised of 6005A-T61 extrusion and 6061-T6 end plates. Secures to an A36 steel base weldment. Gasketed handhole access behind accent panel.

**ELECTRICAL:** Powered by a Class P 120-277VAC primary integral power supply behind gasketed handhole cover behind accent panel. System is 0-10V dimmable. Minimum -40°C operating temperature.

**OPTICAL SYSTEM:** LED boards have solderless connections for field upgradability. Available in 2700K, 3000K, 3500K and 4000K color temperatures with >90 CRI. Optics are UV resistant molded PMMA in Type II and IV distributions. Consult factory for additional lumen output, CCT, and optical distribution options.

**FINISHES AND MATERIALS:** All exterior aluminum parts are polyester powder coat painted to AAMA-2604 standards. Wood pieces are finished with a low VOC waterborne matte exterior finish containing UV and mildew inhibitors. [Care and Maintenance](#)

**HARDWARE:** All luminaire hardware is stainless steel. Anchor bolt kit is hot dipped galvanized.



**LISTINGS & RATINGS:** Luminaire CSA listed according to CSA C22.2 No. 250.0-18/UL Standard 1598. Suitable for wet locations. LM-80 test reported L70 > 60,500 hours and calculated L70 > 154,000 hours.

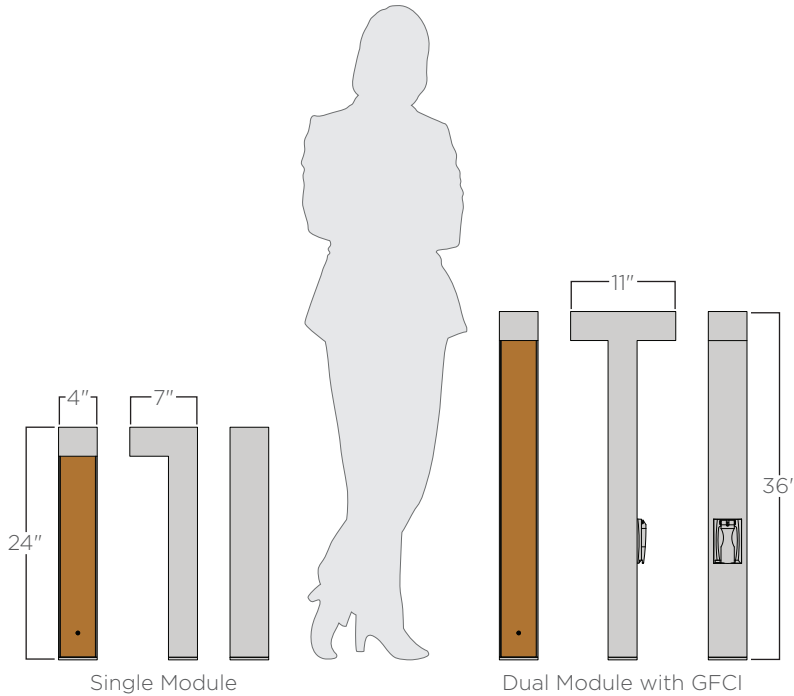

		Standard Output	
Module	Type	Lumens <sup>(1)</sup>	Watts
Single	II	721	11
Single	IV	725	11
Dual	II	1442	22
Dual	IV	1450	22
Dual	II/IV	1446	22
Dual	IV/II	1446	22

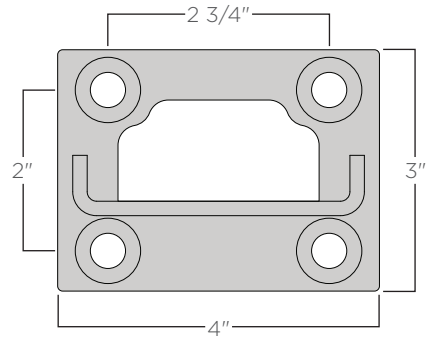

**ORDERING GUIDE:** EXAMPLE: LBL-5-36-L30S0-2-C5-P1/S3-UNV-STD



<b>1</b>	<b>Series</b>
<b>LBL</b>	Lineal Bollard
<b>2</b>	<b>Module</b>
<b>S</b>	Single
<b>D</b>	Dual
<b>3</b>	<b>Overall Height</b>
<b>24</b>	24"
<b>36</b>	36"
<b>4</b>	<b>Light Color</b>
<b>L27</b>	2700K <sup>(2)</sup>
<b>L30</b>	3000K <sup>(2)</sup>
<b>L35</b>	3500K
<b>L40</b>	4000K
<b>AMB</b>	Amber

<b>5</b>	<b>Light Source<sup>(3)</sup></b>
<b>SO</b>	Standard Output
<b>6</b>	<b>Distribution<sup>(4)</sup></b>
<b>2</b>	Type II
<b>4</b>	Type IV
<b>2/4</b>	Front Type II/Back IV
<b>4/2</b>	Front Type IV/Back II
<b>7</b>	<b>Metal Finish</b>
<b>C*</b>	See color options on finishes technical sheet
<b>CSM</b>	Custom Color

<b>8</b>	<b>Panel Material<sup>(5)</sup></b>
<b>P1/S*</b>	Wood (specify color) <sup>(6)</sup>
<b>P2/C*</b>	Aluminum (specify color) <sup>(6)</sup>
<b>9</b>	<b>Voltage</b>
<b>UNV</b>	120-277V
<b>10</b>	<b>Options</b>
<b>GFCI</b>	GFCI Box <sup>(7)</sup>
<b>11</b>	<b>Special</b>
<b>STD</b>	Standard

1. Lumen output based upon 2700K color temperature.  
 2. CCT of 2700K or 3000K color temperature required for DarkSky Approved.  
 3. Consult factory for other output options.  
 4. BUG rating of B0-U1-G1  
 5. Accent panel only on front side of bollard.  
 6. See color options on finishes technical sheet.  
 7. GFCI box requires 36" bollard height.



FIXTURE TYPE: \_\_\_\_\_

PROJECT NAME: \_\_\_\_\_

Single Type II Distribution ┌4'┐



LBL-S-36-L27SO-2-C(X)-P(X)/(XX)-UNV-STD

Single Type IV Distribution ┌4'┐

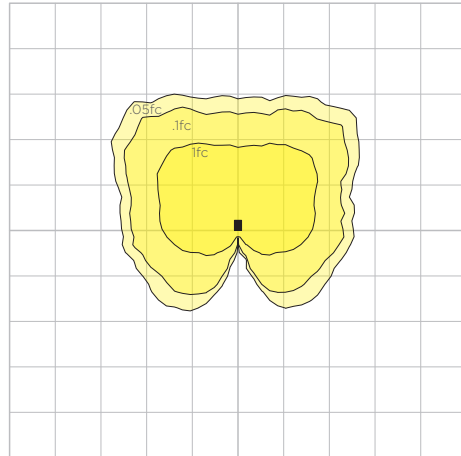

LBL-S-36-L27SO-4-C(X)-P(X)/(XX)-UNV-STD

Dual Type II Distribution ┌4'┐

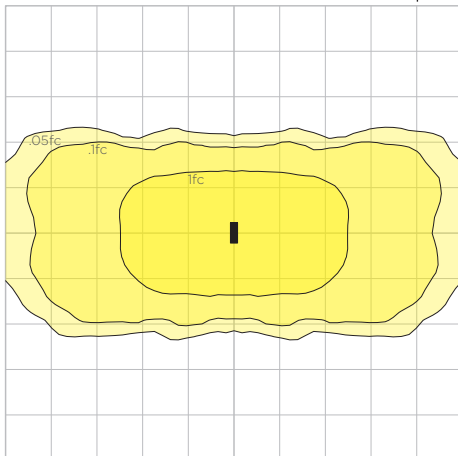

LBL-D-36-L27SO-2-C(X)-P(X)/(XX)-UNV-STD

Dual Type IV Distribution ┌4'┐

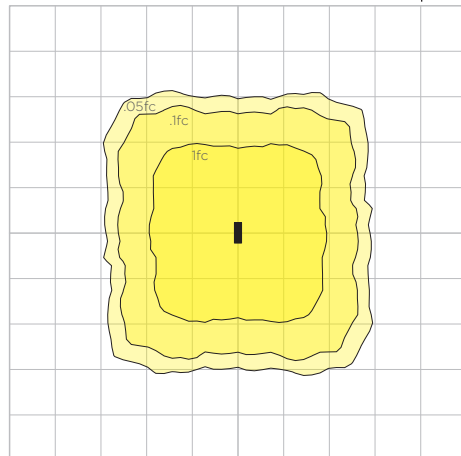

LBL-D-36-L27SO-4-C(X)-P(X)/(XX)-UNV-STD

Dual Type II/IV Distribution ┌4'┐

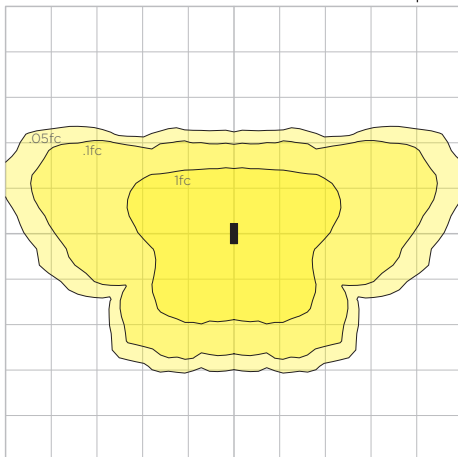

LBL-D-36-L27SO-2/4-C(X)-P(X)/(XX)-UNV-STD

Dual Type IV/II Distribution ┌4'┐

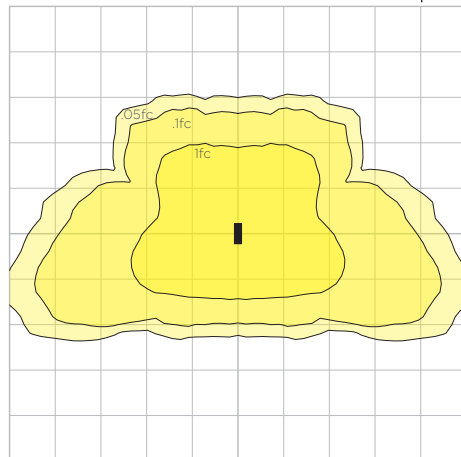

LBL-D-36-L27SO-4/2-C(X)-P(X)/(XX)-UNV-STD

[IES file download](#)

# ULEE-30041

## Leeds 3 Medium Surface Up/Downlight



2x14w LED 2x1675 Lumens  
IP65 · Suitable For Wet Locations  
IK07 · Impact Resistant  
Weight 4 lbs

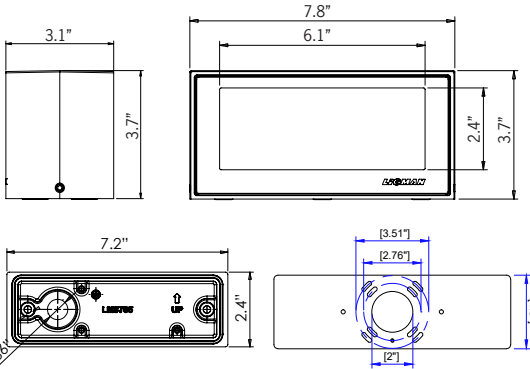

Mounting Detail



Ligman's micro Variable Optical System provides the ability to interchange, mix & rotate optics to provide specific light distributions for optimized spacing and uniformity.

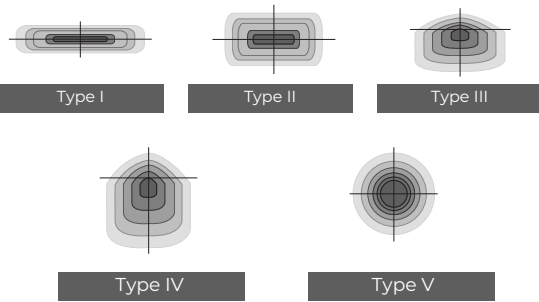

The variable optic system allows for the designer to create hybrid distributions for precise lighting requirements.

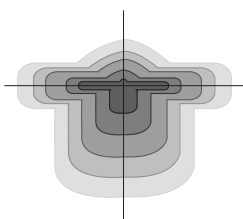

HYBRID  
TYPE I & TYPE IV

### Construction

**Aluminum**  
Less than 0.1% copper content - Marine Grade 6060 extruded & LM6 Aluminum High Pressure die casting provides excellent mechanical strength, clean detailed product lines and excellent heat dissipation.

**Pre-paint**  
8 step degrease and phosphate process that includes deoxidizing and etching as well as a zinc and nickel phosphate process before product painting.

**Memory Retentive - Silicon Gasket**  
Provided with special injection molded "fit for purpose" long life high temperature memory retentive silicon gaskets. Maintains the gaskets exact profile and seal over years of use and compression.

**Thermal management**  
LM6 Aluminum is used for its excellent mechanical strength and thermal dissipation properties in low and high ambient temperatures. The superior thermal heat sink design by Ligman used in conjunction with the driver, controls thermal below critical temperature range to ensure maximum luminous flux output, as well as providing long LED service life and ensuring less than 10% lumen depreciation at 50,000 hours.

**Surge Suppression**  
Standard 10kv surge suppressor provided with all fixtures.

**BUG Rating**  
Contact Factory

**Finishing**  
All Ligman products go through an extensive finishing process that includes fettling to improve paint adherence.

**Paint**  
UV Stabilized 4.9Mil thick powder coat paint and baked at 200 Deg C. This process ensures that Ligman products can withstand harsh environments. Rated for use in natatoriums.

#### MicroPRIM Finishes

MicroPRIM is Ligman's trade marked decorative powder coating technology that permanently infuses colors, patterns, or imagery directly into the surface of luminaires and poles while providing protections that standard powder coating does not offer.

MicroPRIM finishes include nature-inspired wood grains and stone aesthetics, material-inspired finishes such as brushed metal, concrete, and carbon fiber. Solid colors in Ligman standard colors, as well as any RAL or Pantone color, Decorative patterns, custom imagery and more.

#### Coating and Infusion Process

Metal components are pre-treated and powder coated with a proprietary polyurethane-based coating engineered for outdoor architectural use. Decorative patterns or imagery are then permanently infused into the cured powder coat through a heat-based process, creating a durable, integrated finish.

#### Performance and Validation

MicroPRIM finishes are suitable for indoor and outdoor applications and meet AAMA2605 architectural coating requirements. Performance is validated through laboratory and real-world testing to ASTM standards for UV exposure, adhesion, abrasion, impact, salt spray, chemical resistance, and graffiti resistance.

All MicroPRIM finishes are backed by Ligman's 10-year warranty.

#### Key Performance Attributes

- Anti-graffiti resistance
- UV and weather resistance
- Scratch and abrasion resistance
- Natatorium Rated for installation in corrosive environments)

#### Hardware

Provided Hardware is Marine grade 316 Stainless steel.

#### Anti-Seize Screw Holes

Tapped holes are infused with a special anti-seize compound designed to prevent seizure of threaded connections, due to electrolysis from heat, corrosive atmospheres and moisture.

#### Crystal Clear Low Iron Glass Lens

Provided with tempered, impact resistant crystal clear low iron glass ensuring no green glass tinge.

#### Optics & LED

Precise optic design provides exceptional light control and precise distribution of light. LED CRI > 80

#### Lumen - Maintenance Life

L80 /B10 at 50,000 hours (This means that at least 90% of the LED still achieve 80% of their original flux)

Clean, elegant surface-mounted wall fixtures delivering class-leading performance. A minimalist design paired with exceptional power and flexibility, offering lumen packages up to 3,668 lumens—or dual configurations up to 4,982 lumens—featuring advanced MicroVos technology.

A range of small, square and rectangular, ADA compliant wall mounted luminaires with options of upward or downward light distributions. Ideally suited to illuminate the wall and surfaces in front of wall and for light accents on vertical surfaces using high efficiency LED's. The Leeds is suitable for indoor and outdoor applications and provides a clean, visually appealing solution for small, unobtrusive wall mounted luminaires.

This luminaire is available in 3 different sizes and in combinations of down, up or up/down light distributions.

This fixture utilizes MicroVos Technology, meaning the ability to do Type I, II, III, IV & V distributions as well as hybrid distributions to suit the designer's requirements.

Using the MicroVos Optics allows for very wide spacing to mounting height ratios, while still providing perfect uniformity and code compliant light levels.

### Additional Options (Consult Factory For Pricing)

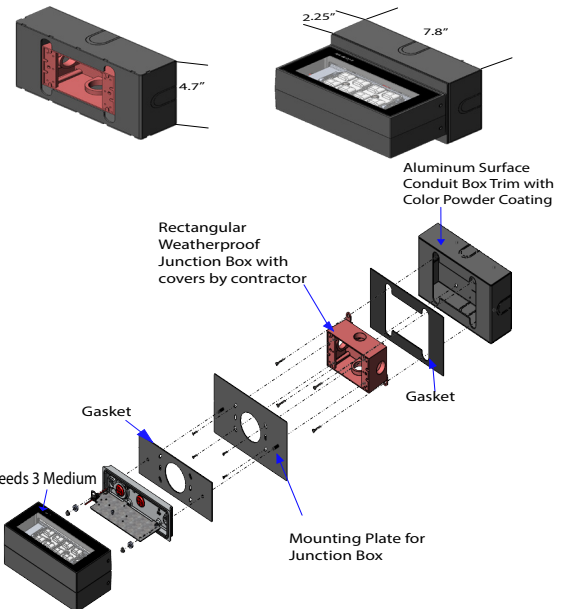

### SCBT Surface Conduit Box Trim

NOTE: This trim covers a shallow single gang, surface mount junction box [Provided by contractor]  
Example: Hubbell: - 5322-0 - 1-Gang Weatherproof Box, Five 1/2" in. Threaded Outlets - or - 5332-0 - 1-Gang Weatherproof Box, Five 3/4 in. Threaded Outlets

# ULEE-30041

## Leeds 3 Medium Surface Up/Downlight



PROJECT		DATE	
---------	--	------	--

QUANTITY		TYPE		NOTE	
----------	--	------	--	------	--

ORDERING EXAMPLE || ULEE - 30041 - 2x14w - T2 - W - W30 - 02 - 120/277v - Options

ULEE-30041						
LAMP	BEAM UP	BEAM DOWN	LED COLOR	FINISH COLOR		VOLTAGE
2 x 14w LED 2 x 1,676 Lumens	T1 - Type I Distribution T2 - Type II Distribution T3 - Type III Distribution T4 - Type IV Distribution M - Medium 30° W - Wide 56° EW - Extra Wide 99°x102°	T1 - Type I Distribution T2 - Type II Distribution T3 - Type III Distribution T4 - Type IV Distribution M - Medium 30° W - Wide 56° EW - Extra Wide 99°x102°	W27 - 2700K W30 - 3000K W35 - 3500K W40 - 4000K AMB - <b>TURTLE FRIENDLY</b> Amber LED	01 - BLACK RAL 9011 02 - DARK GREY RAL 7043 03 - WHITE RAL 9003 04 - METALLIC SILVER RAL 9006 05 - MATTE SILVER RAL 9006 06 - LIGMAN BRONZE 07 - CUSTOM RAL		120/277v

--	--	--	--

### ADDITIONAL OPTIONS

### CITY OF FLAGSTAFF & TURTLE FRIENDLY COMPLIANT

- NAT - Natatorium Rated
- SCBT - Surface Conduit Box Trim
- F - Frosted Lens
- DIM - 0-10v Dimming

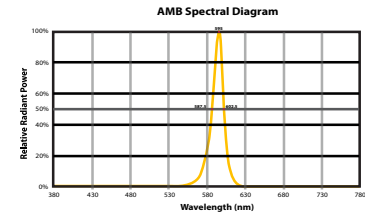

**Narrow-Spectrum Amber LEDs**  
Peak wavelength between 585 & 595 nanometers and a full width of 50% power no greater than 15 nanometers.

## More Custom Finishes Available Upon Request

Consult factory for pricing and lead times

#### MicroPRIM FINISHES

- SW01 - OAK FINISH
- SW02 - WALNUT FINISH
- SW03 - PINE FINISH
- DF - DOUGLAS FIR FINISH
- CW - CHERRY WOOD FINISH
- NW - NATIONAL WALNUT FINISH
- SU01 - CONCRETE FINISH
- SU02 - SOFTSCAPE FINISH
- SU03 - STONE FINISH
- SU04 - CORTEN FINISH
- CSM - Custom Image/Pattern

#### MicroPRIM FINISHES

- MP - MAPLE FINISH
- MHG - MAHOGANY FINISH
- BH - BEECH FINISH
- CN - CHESTNUT FINISH
- WMBL - WHITE MARBLE FINISH
- MBL - MARBLE FINISH
- GRNT - GRANITE FINISH
- BGD - BRUSHED GOLD FINISH
- BBRZ - BRUSHED BRONZE FINISH
- CAMO - CAMOUFLAGE FINISH

- MP01 - MicroPRIM RAL 9011 Black (Glossy)
- MP02 - MicroPRIM RAL 7043 Dark Grey (Glossy)
- MP03 - MicroPRIM RAL 9003 White (Glossy)
- MP04 - MicroPRIM RAL 9006 Metallic Silver (Glossy)
- MP05 - MicroPRIM RAL 9006 Matte Silver (Matte/Textured)
- MP06 - MicroPRIM Ligman Bronze (Glossy)
- MP07 - MicroPRIM Custom Color (Glossy)

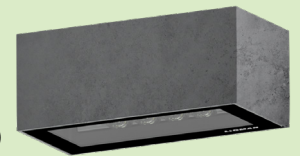

MicroPRIM Finish



# Leeds Product Family



Leeds 1 - Up/Down

· ULEE-30031-2x5.5w-2x570lm



Leeds 2 - Down

· ULEE-30001-5.5w-570lm



Leeds 3 - Up/Down

· ULEE-30041-2x14w-2x1660lm



Leeds 4 - Down

· ULEE-30011-14w-1660lm



Leeds 5 - Up/Down

· ULD-30051-2x20w-2x2422lm



Leeds 6 - Down

· ULEE-30021-20w-2422lm

Project Name: ..... Location: .....

Specifier: ..... Rep Agency: .....

Fixture Type: ..... Product Code: .....

# KLIK LEDpod™ 50 Patented

## DESCRIPTION

Discrete, seamless point source LED fixture for use in all code-compliant handrail, especially curving ramps and helical stairs as well as long runs on bridges and pedestrian paths. Asymmetric optic allows mounting at rail nadir, eliminating uncomfortable glare issues. Typical spacing between LEDpods on stairs is 24", and on level runs is 48".

## HOUSING

Aluminum body has a fine 25-micron finish and is then hard-coat anodized, thus preventing galvanic corrosion. Silicone gasket seals the installation from water ingress and provides added means of electrical isolation to minimize potential for galvanic reaction.

## MOUNTING

Patented attachment method offers unparalleled security and ease of mounting. Requires only a simple drilled hole in railing material. All conductors remain internal to railing to provide secure and safe wiring. IK10 Impact rating ensures vandal resistance.

- Tube Size:  $\varnothing$  1.75" - 2.00", Max. wall .22"  
*Other sizes available upon request.*
- Cut Out: 25mm
  - Must use a 25mm annular cutter [NOT a 1" cutter].

## ELECTRICAL/LED DRIVER

- Input Voltage: 24 VDC
- Driver: Must use class 2 driver
  - Primary Driver: 110 - 277 VAC UL Listed Constant Voltage
  - Secondary Driver: 350 - 700mA Constant Current (provided with fixture)
- Control: 0-10V, DALI, DMX
  - DMX control for dimming only, not for individually addressed LEDpod
- Enclosure: Minimum NEMA2 for indoor, NEMA 3R for outdoor
- Wire connectors provided; factory pre-wire available, consult factory

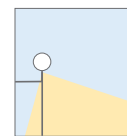
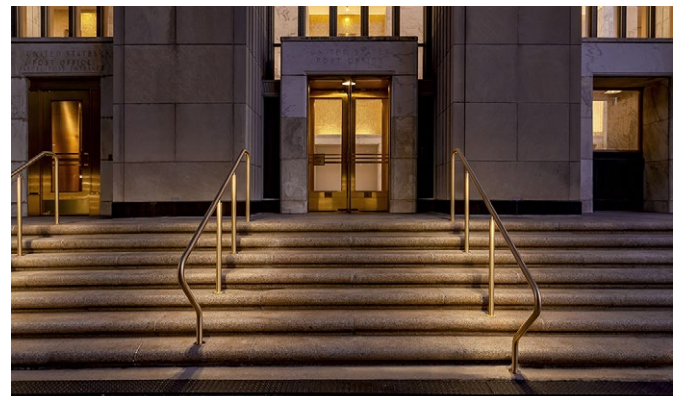
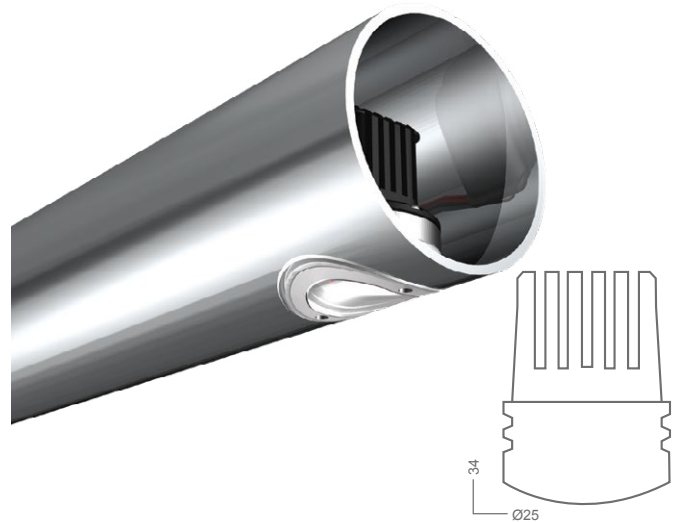

Asymmetrical  
65° beam

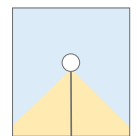

Symmetrical  
90° beam



**ETL listed**  
UL 1598/CSA 22.2; CE



**LED Operating Temp:**  
-40°F - 160°F



**Weatherproof Rating:**  
IP66  
Wet location rated



**3G Vibration**  
per MIL-STD-810G



**Impact resistance:**  
IK10



**Wildlife friendly**



**International Dark Sky Association Certified** Amber  $\leq$  3000K

\* All IP rated luminaires tested to AS60529-2004 Degrees of protection provided by enclosures (IP Code)

# KLIK LEDpod™ 50 Patented

## SPECIFICATION TABLE

Follow the steps to specify your fixture. Enter Product Code in field at top of page. Example: LP5030KA

Fixture Type	Color Temp [K]	Distribution	Rail Wall Thickness <sup>1,2</sup>	Lens Options	Security	Output (W)	Anodized Bezel Options	Control
LP50	22K 2200K	<b>A</b> Asymmetric	<b>05</b> 1 1/2 SC5 Pipe	- Clear lens [Std]	- Tamper resistant [Std]	- 500mA 2W [Std]	- Marine grade anodized [Std]	- 0-10V Dim
	27K 2700K	<b>S</b> Symmetric	<b>10</b> 1 1/2 SC10 Pipe	<b>FR</b> Opaque frost	<b>TP</b> Tamperproof	<b>350</b> 350mA 1.5W	<b>BRS</b> Antique Brass	<b>DMX1</b> DMX 1 Ch
	30K 3000K		<b>40</b> 1 1/2 SC40 Pipe	<b>OT</b> Optical filter	[Requires the KLIK tool]	<b>700</b> 700mA 2.7W	<b>BLK</b> Black Anodized	<b>PH</b> [Phase dim]
	35K 3500K		<b>80</b> 1 1/2 SC80 Pipe				<b>BZ</b> Bronze	
	40K 4000K		<b>2012</b> 2.0"x11ga Tube [.12 Wall]				<b>ANT</b> Dark Antique	
	<b>AMB</b> FWC Amber		<b>CUST</b> Non-stock				<b>GLD</b> Rose Gold	
	<b>PCA</b> Phos-converted Amber							
	<b>R</b> Red							
	<b>G</b> Green							
	<b>B</b> Blue							

<sup>1</sup>Other sizes available for 2" tube

<sup>2</sup>Clips for Bronze railing requires a special alloy | consult factory

LED PERFORMANCE		Outputs based on 3000K			SYMMETRICAL	ASYMMETRICAL
LED:	Cree XT-E	<b>W</b>	<b>mA</b>	<b>V</b>	<b>Delivered Lumens</b>	
CCT:	2700, 3000, 4000 (others available)	1.4	350	3	116	86
CRI:	80-85	1.9	500	3	166	130
Life:	80% at 50k hrs and 85°C	2.7	700	3	215	170
Binning:	3 MacAdam Steps					
Warranty:	5 Year Warranty					

REMOTE MOUNTING DISTANCE CHART				
24 VDC 100W Driver	Approx. distance from driver to first LED at 32 fixtures			
Wire Size	10 AWG	12 AWG	14 AWG	16 AWG
Distance	525'	328'	213'	131'

Calculations based on 2' centers between pods. Increased spacing reduces number of pods per circuit.

PRIMARY DRIVER			
110 - 277 Primary Voltage Remotely Mounted Dimming Control 10" x 1.5" x 2"	Secondary LED Driver	Spacing	Maximum KLIK LEDpods™*
	700mA	24"	30
	500mA	24"	37
	350mA	24"	50

\*Based on 16 AWG between LEDpods

REMOTE POWER SUPPLIES [PSUs]	
LP040WPRITRDIMIP	Class 2; 40W; 0-10 Dim Constant Voltage Remote PSU [IP67 (Temp Submersion) Rated; -40°C ~ +85°C]
LP096WPRITRDIM	Class 2, 96W, 0-10 Dim Constant Voltage Remote PSU [IP67 (Temp Submersion) Rated; -40°C ~ +80°C]
LP100WPRITRDIM	Class 2, 96W, 0-10 Dim Constant Voltage Remote PSU [IP64 (Damp Location) Rated; -25°C ~ +40°C]
LPQZ96WUNV24VPH010	Class 2, 96W, Phase or 0-10 Dim Constant Voltage Remote PSU [IP66 (Wet Location) Rated; -40°C ~ +60°C]
LPQZ96WUNV24VDMX1CH	Class 2, 96W, 8-Bit DMX Dim Constant Voltage Remote PSU [IP66 (Wet Location) Rated; -40°C ~ +60°C]

REMOTE NEMA ENCLOSURES	
LPNEMA2RENCL	NEMA2 INDOOR enclosure for LP100WPRITRDIM, 12 x 3.3 x 2
LPNEMA3RENCLJR	NEMA3R Drip Proof Enclosure, 4 x 4 x 12 [IP24 Equivalent]
LPNEMA3RXENCLSS	NEMA3 304 Lockable Stainless Steel Drip Proof Enclosure 4 x 4 x 12 [IP24 Equivalent]
LPNEMA4ENCLJR	NEMA4 Watertight Enclosure, 6 x 4 x 12 [IP66 Equivalent]; NEMA4X
LPNEMA4XENCLSSJR	NEMA4 304 Lockable Stainless Steel Watertight Enclosure 6 x 4 x 12 [IP66 Equivalent] NEMA4X
LPNEMA6PTRO	NEMA6 Watertight Enclosure Wiring Trough, 2 x 3 x 14 [IP68 Equivalent]

Additional driver & enclosure configurations available, including IP68 options  
Please note the KLIK UL Listing requires purchase of a remote driver and enclosure.

# KLIK LEDpod™ 50 Patented SINGLE SIDED

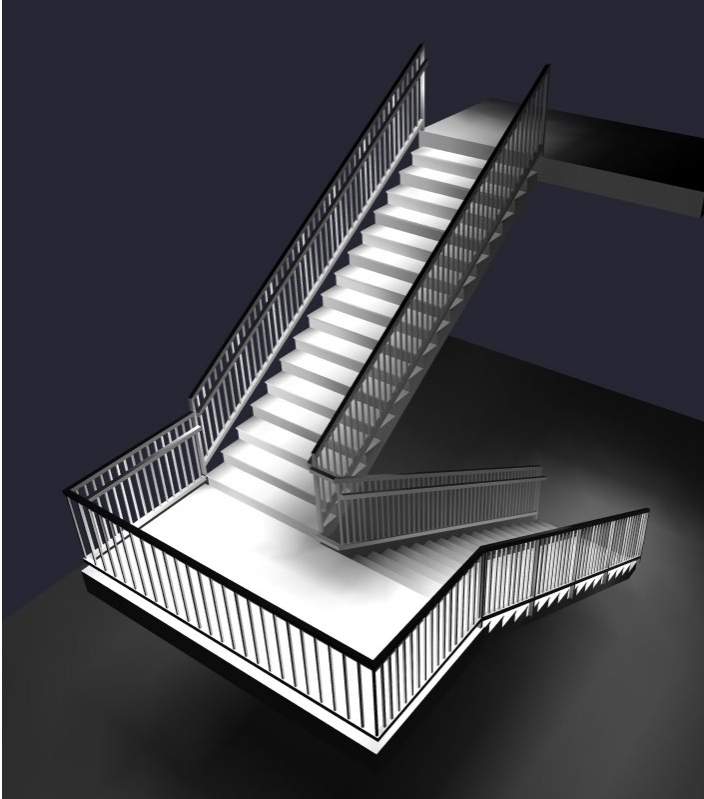

QTY	LABEL	ARRANGEMENT	LUMENS	LLF	DESCRIPTION
26	A	Single	130	0.900	LPOD50-3K-500mA-2.0W-Asym Clear Lens

Landing readings taken on landing. Stair readings taken on stair. (Design based on 2' centers.)

LABEL	UNITS	AVG	MAX	MIN	AVG/MIN	MAX/MIN
Landing	Fc	13.73	22.2	3.0	4.58	7.40

STAIRS	UNITS	AVG	MAX	MIN	AVG/MIN	MAX/MIN
1-1	Fc	3.99	5.9	0.9	4.43	6.56
1-10	Fc	6.83	12.0	0.9	7.59	13.33
1-11	Fc	6.68	11.3	0.9	7.42	12.56
1-12	Fc	6.86	12.1	0.9	7.62	13.44
1-13	Fc	6.50	11.1	0.8	8.13	13.88
1-14	Fc	6.84	12.1	0.8	8.55	15.13
1-15	Fc	6.43	11.2	0.8	8.04	14.00
1-16	Fc	6.88	12.4	0.6	11.47	20.67
1-17	Fc	6.14	10.9	0.6	10.23	18.17
1-2	Fc	6.11	9.9	0.9	6.79	11.00
1-3	Fc	7.00	12.2	0.9	7.78	13.56
1-4	Fc	6.64	11.4	1.0	6.64	11.40
1-5	Fc	7.04	12.2	0.9	7.82	13.56
1-6	Fc	6.73	11.6	1.0	6.73	11.60
1-7	Fc	6.96	11.9	0.9	7.73	13.22
1-8	Fc	6.80	11.9	0.9	7.56	13.22
1-9	Fc	6.86	11.7	0.9	7.62	13.00
2-1	Fc	8.36	14.5	2.1	3.98	6.90
2-10	Fc	7.33	12.6	1.9	3.86	6.63
2-11	Fc	7.60	13.5	1.7	4.47	7.94
2-12	Fc	7.28	12.7	2.0	3.64	6.35
2-13	Fc	7.74	13.5	1.7	4.55	7.94
2-14	Fc	7.00	13.0	1.5	4.67	8.67
2-15	Fc	6.56	11.8	1.1	5.96	10.73
2-16	Fc	5.65	11.2	0.7	8.07	16.00
2-2	Fc	8.10	14.3	1.9	4.26	7.53
2-3	Fc	7.05	13.1	1.5	4.70	8.73
2-4	Fc	7.85	13.6	1.8	4.36	7.56
2-5	Fc	7.25	13.4	1.6	4.53	8.38
2-6	Fc	7.66	12.9	1.8	4.26	7.17
2-7	Fc	7.45	13.5	1.6	4.66	8.44
2-8	Fc	7.46	12.6	1.8	4.14	7.00
2-9	Fc	7.56	13.7	1.6	4.73	8.56

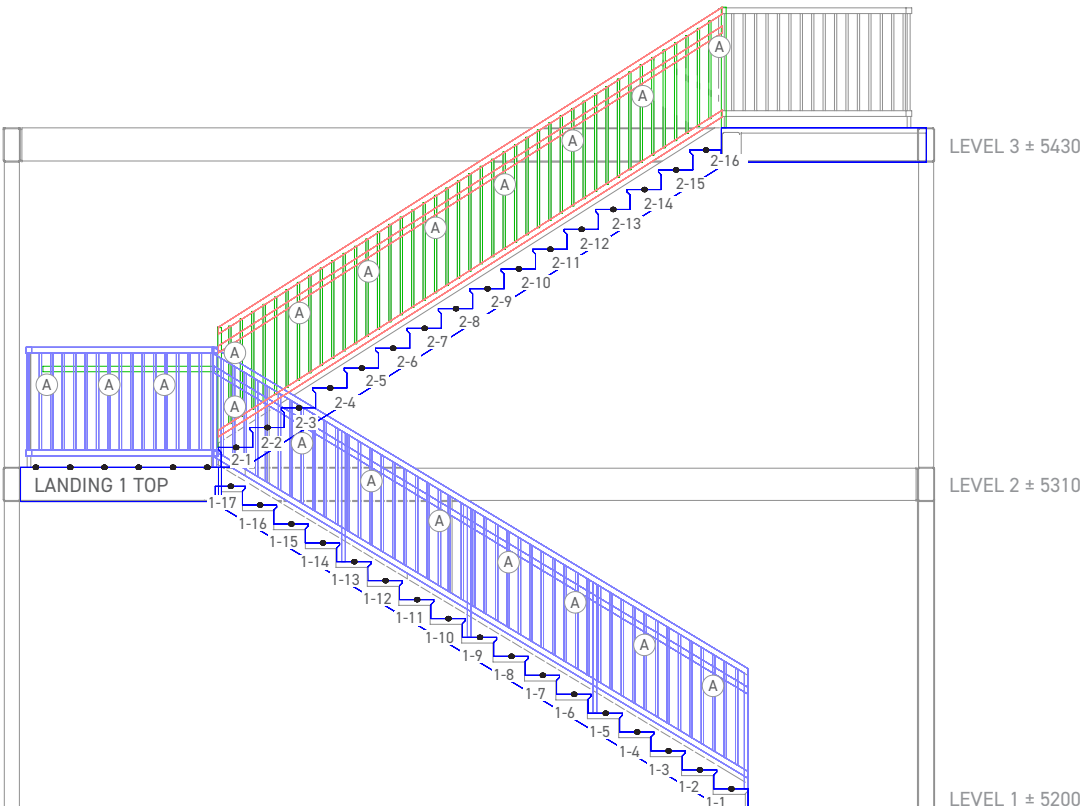

# KLIK LEDpod™ 50 Patented SINGLE SIDED

## LANDING 1 TOP

2	5'-11 1/4"		9.4	12.9	13.8	12.8	11.5	10.7	10.5	10.8	11.7	13.1	14.2	12.9	9.9						
			14.3	18.8	19.8	18.3	16.4	15.2	14.9	15.4	16.8	18.9	20.5	19.2	15.1						
			16.1	20.6	20.9	18.4	15.8	14.2	13.9	14.6	16.7	19.6	22.2	21.6	16.4						
			15.0	19.0	18.5	14.9	11.7	10.0	9.8	10.9	13.4	16.9	20.1	20.3	15.2						
			13.4	16.8	15.2	10.9	7.2	5.6	5.7	6.8	9.4	12.9	16.2	17.0	12.8						
			12.6	15.6	13.3	8.6	4.7	3.0	3.2	3.5	6.5	9.6	12.7	14.1	8.8						
1.8	± 26'-8"	15'-0 1/2"	STAIRS 1-17	10.2	10.9	9.9	7.3	5.1	3.4	1.7	0.6		2.1	3.2	4.9	7.5	10.2	13.2	14.5	11.3	STAIRS 2-1
			STAIRS 1-16	10.4	12.4	11.5	8.9	6.0	3.5	1.7	0.6		1.9	2.8	4.4	6.9	10.0	12.7	14.3	11.8	STAIRS 2-2
			STAIRS 1-15	10.0	11.2	10.2	7.9	5.6	3.7	2.0	0.8		1.8	2.8	4.5	6.9	9.7	12.1	13.6	11.4	STAIRS 2-3
			STAIRS 1-14	10.2	12.1	11.2	8.7	6.0	3.7	2.0	0.8		1.5	2.5	3.9	5.7	8.1	11.5	13.1	10.1	STAIRS 2-4
			STAIRS 1-13	9.7	11.1	10.2	8.2	5.9	4.0	2.1	0.8		1.6	2.5	3.8	5.8	8.7	11.8	13.4	10.4	STAIRS 2-5
			STAIRS 1-12	10.2	12.1	11.2	8.7	5.9	3.8	2.1	0.9		1.8	2.9	4.7	6.9	9.5	11.6	12.9	11.0	STAIRS 2-6
			STAIRS 1-11	9.9	11.3	10.5	8.4	6.1	4.1	2.2	0.9		1.6	2.6	3.9	6.1	9.1	12.0	13.5	10.8	STAIRS 2-7
			STAIRS 1-10	10.0	12.0	11.1	8.6	5.9	3.9	2.2	0.9		1.8	3.0	4.6	6.7	9.2	11.3	12.6	10.5	STAIRS 2-8
			STAIRS 1-9	10.2	11.7	10.8	8.7	6.3	4.1	2.2	0.9		1.6	2.6	3.9	6.4	9.2	12.1	13.7	11.0	STAIRS 2-9
			STAIRS 1-8	10.0	11.9	11.0	8.4	5.9	4.0	2.3	0.9		1.9	3.0	4.6	6.5	8.7	11.2	12.6	10.1	STAIRS 2-10
			STAIRS 1-7	10.3	11.9	11.1	8.9	6.3	4.1	2.2	0.9		1.7	2.6	4.1	6.6	9.3	12.0	13.5	11.0	STAIRS 2-11
			STAIRS 1-6	9.9	11.6	10.8	8.3	5.9	4.0	2.3	1.0		2.0	3.1	4.5	6.4	8.3	11.3	12.7	9.9	STAIRS 2-12
			STAIRS 1-5	10.4	12.2	11.3	8.9	6.3	4.1	2.2	0.9		1.7	2.7	4.4	6.8	9.6	12.0	13.5	11.2	STAIRS 2-13
			STAIRS 1-4	9.7	11.4	10.5	8.2	5.9	4.1	2.3	1.0		1.5	2.5	3.8	5.7	8.2	11.4	13.0	9.9	STAIRS 2-14
STAIRS 1-3	10.3	12.2	11.3	8.9	6.2	4.0	2.2	0.9		1.1	1.9	3.5	5.7	8.3	10.3	11.8	9.9	STAIRS 2-15			
STAIRS 1-2	8.8	9.9	9.3	7.7	5.9	4.1	2.3	0.9		0.7	1.4	2.3	4.2	6.9	9.7	11.2	8.8	STAIRS 2-16			
STAIRS 1-1	4.8	5.9	5.7	5.1	4.2	3.3	2.0	0.9													
1.2	5'-8 1/4"																				
		Stair width - 5'8"																			
1																					

# KLIK LEDpod™ 50 Patented DOUBLE SIDED

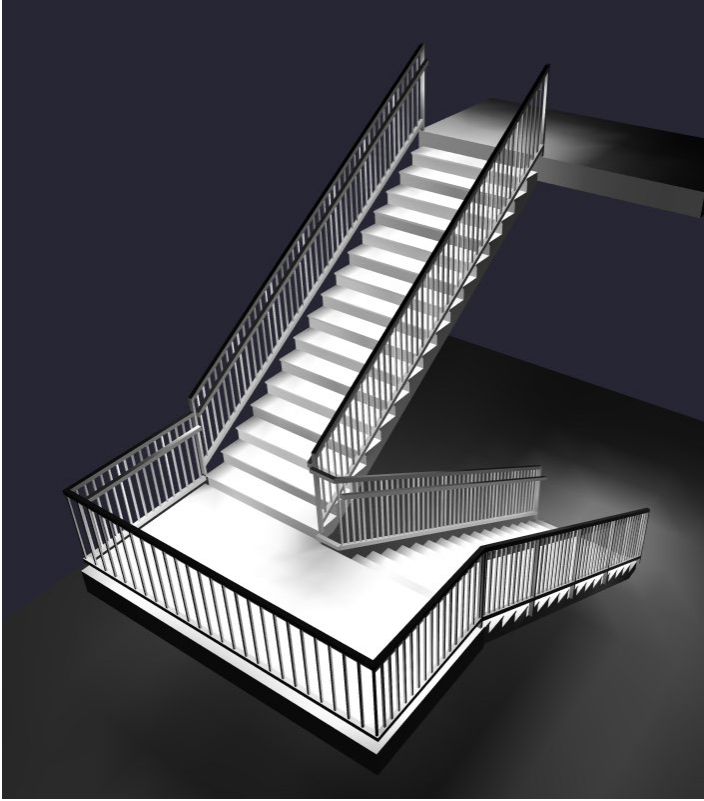

QTY	LABEL	ARRANGEMENT	LUMENS	LLF	DESCRIPTION
42	A	Single	130	0.900	LPOD50-3K-500mA-2.0W-Asym Clear Lens

Landing readings taken on landing. Stair readings taken on stair. (Design based on 2' centers.)

LABEL	UNITS	AVG	MAX	MIN	AVG/MIN	MAX/MIN
Landing	Fc	15.37	23.9	6.6	2.33	3.62

STAIRS	UNITS	AVG	MAX	MIN	AVG/MIN	MAX/MIN
1-1	Fc	7.88	9.6	3.5	2.25	2.74
1-10	Fc	13.25	15.7	6.1	2.17	2.57
1-11	Fc	13.11	15.3	6.2	2.11	2.47
1-12	Fc	13.35	15.7	6.2	2.15	2.53
1-13	Fc	12.69	14.6	6.0	2.12	2.43
1-14	Fc	13.20	15.3	6.4	2.06	2.39
1-15	Fc	12.20	14.0	5.9	2.07	2.37
1-16	Fc	12.61	14.7	6.0	2.10	2.45
1-17	Fc	10.50	12.3	5.0	2.10	2.46
1-2	Fc	11.95	13.9	5.6	2.13	2.48
1-3	Fc	13.63	15.8	6.3	2.16	2.51
1-4	Fc	12.95	15.0	6.2	2.09	2.42
1-5	Fc	13.75	15.9	6.4	2.15	2.48
1-6	Fc	13.18	15.3	6.3	2.09	2.43
1-7	Fc	13.74	15.9	6.8	2.02	2.34
1-8	Fc	13.16	15.5	6.0	2.19	2.58
1-9	Fc	13.45	15.6	6.6	2.04	2.36
2-1	Fc	14.94	17.7	10.8	1.38	1.64
2-10	Fc	14.39	15.6	11.7	1.23	1.33
2-11	Fc	15.03	16.0	12.6	1.19	1.27
2-12	Fc	14.31	15.8	11.8	1.21	1.34
2-13	Fc	15.38	16.3	12.8	1.20	1.27
2-14	Fc	13.70	15.3	11.3	1.21	1.35
2-15	Fc	13.03	13.8	11.0	1.18	1.25
2-16	Fc	11.06	12.5	9.4	1.18	1.33
2-2	Fc	15.96	17.0	13.5	1.18	1.26
2-3	Fc	13.85	15.6	11.2	1.24	1.39
2-4	Fc	15.59	16.6	13.1	1.19	1.27
2-5	Fc	14.33	15.9	11.7	1.22	1.36
2-6	Fc	15.21	16.3	12.6	1.21	1.29
2-7	Fc	14.74	16.0	12.2	1.21	1.31
2-8	Fc	14.74	15.9	12.1	1.22	1.31
2-9	Fc	14.94	16.1	12.6	1.19	1.28

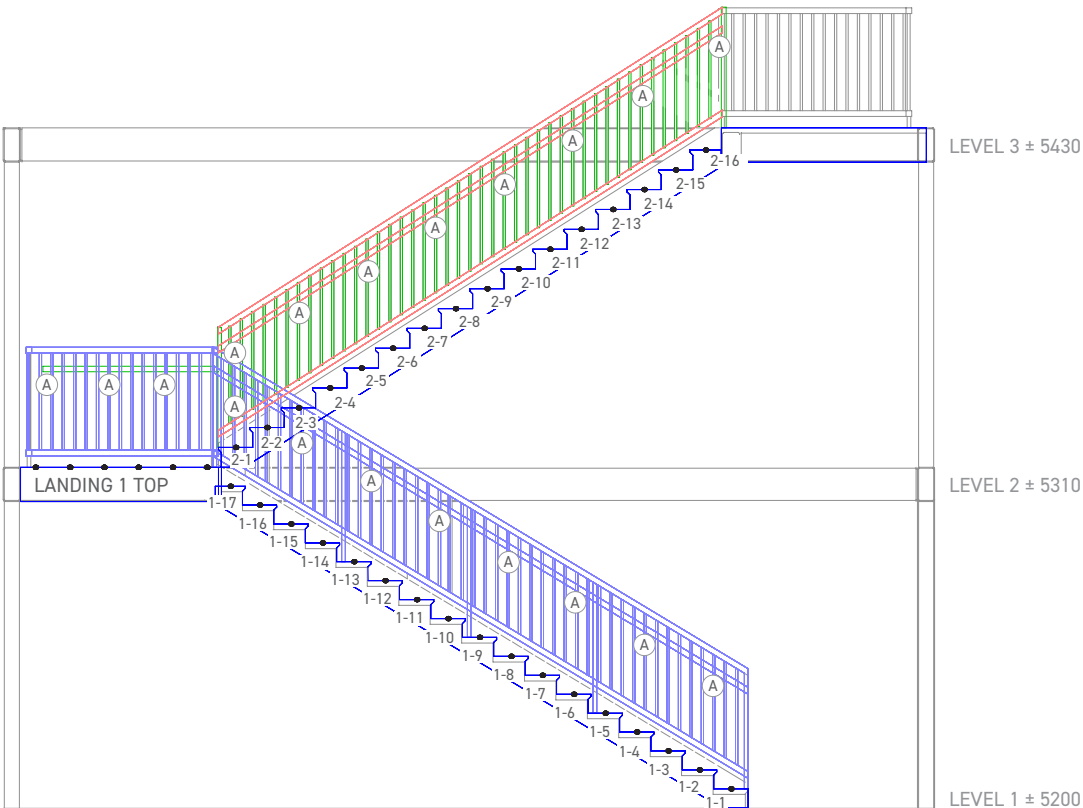

# KLIK LEDpod™ 50 Patented DOUBLE SIDED

## LANDING 1 TOP

2	5'-11 1/4"	9.5	12.9	13.9	12.9	11.6	10.8	10.7	11.1	12.2	13.6	14.7	13.4	10.3						
		14.3	18.9	19.9	18.5	16.6	15.4	15.2	16.0	17.7	19.9	21.4	20.0	15.7						
		16.2	20.7	21.1	18.8	16.3	14.6	14.6	16.0	18.5	21.5	23.9	22.9	17.4						
		15.2	19.3	19.1	16.4	13.5	11.4	11.4	13.6	16.6	20.0	22.8	22.4	16.9						
		13.6	17.3	16.8	14.4	12.1	9.6	8.4	10.7	14.0	17.1	19.8	19.7	15.0						
		12.9	16.3	15.6	13.5	11.7	9.4	6.6	7.1	11.4	14.1	16.3	16.8	10.4						
		1.8	± 26'-8"	15'-0 1/2"	STAIRS 1-17 SIDE 66	11.0	12.2	12.3	11.1	11.1	11.9	9.4	5.0	10.8	13.7	14.7	15.2	16.5	17.7	17.6
STAIRS 1-16 SIDE 62	11.4	14.1			14.7	14.4	14.3	14.2	11.8	6.0	13.7	16.5	16.7	16.6	16.8	17.0	16.9	13.5	STAIRS 2-2 SIDE 8	
STAIRS 1-15 SIDE 58	11.3	13.5			14.0	13.6	13.6	13.9	11.8	5.9	11.2	15.3	15.0	13.4	13.7	15.2	15.6	11.4	STAIRS 2-3 SIDE 12	
STAIRS 1-14 SIDE 54	11.6	14.5			15.1	14.9	15.1	15.3	12.7	6.4	13.1	16.3	16.4	16.5	16.6	16.5	16.2	13.1	STAIRS 2-4 SIDE 16	
STAIRS 1-13 SIDE 50	11.2	13.8			14.6	14.5	14.6	14.6	12.2	6.0	11.7	15.8	15.6	14.0	14.2	15.5	15.9	11.9	STAIRS 2-5 SIDE 20	
STAIRS 1-12 SIDE 46	11.8	14.8			15.3	15.0	15.3	15.7	12.7	6.2	12.8	15.8	16.1	16.3	16.2	16.2	15.7	12.6	STAIRS 2-6 SIDE 24	
STAIRS 1-11 SIDE 42	11.5	14.1			15.0	15.1	15.3	15.1	12.6	6.2	12.2	16.0	15.8	14.9	14.9	15.7	16.0	12.4	STAIRS 2-7 SIDE 28	
STAIRS 1-10 SIDE 38	11.8	14.8			15.3	14.8	15.0	15.7	12.5	6.1	12.4	15.2	15.7	15.6	15.6	15.9	15.4	12.1	STAIRS 2-8 SIDE 32	
STAIRS 1-9 SIDE 34	11.8	14.5			15.4	15.5	15.6	15.4	12.8	6.6	12.6	16.0	15.9	15.5	15.3	15.5	16.1	12.6	STAIRS 2-9 SIDE 36	
STAIRS 1-8 SIDE 30	11.8	14.8			15.3	14.7	14.9	15.5	12.3	6.0	11.9	15.0	15.3	15.0	15.0	15.6	15.6	11.7	STAIRS 2-10 SIDE 40	
STAIRS 1-7 SIDE 26	12.0	14.8			15.6	15.8	15.9	15.8	13.2	6.8	12.8	15.8	16.0	15.7	15.6	15.8	15.9	12.6	STAIRS 2-11 SIDE 44	
STAIRS 1-6 SIDE 22	11.8	14.7			15.3	14.6	14.6	15.2	12.9	6.3	11.8	15.4	15.3	14.2	14.5	15.8	15.7	11.8	STAIRS 2-12 SIDE 48	
STAIRS 1-5 SIDE 18	12.2	15.1			15.8	15.8	15.9	15.8	13.0	6.4	13.1	16.1	16.3	16.2	16.3	16.2	16.0	12.8	STAIRS 2-13 SIDE 52	
STAIRS 1-4 SIDE 14	11.6	14.4			15.0	14.6	14.5	14.8	12.5	6.2	11.3	15.1	14.8	13.2	13.6	15.0	15.3	11.3	STAIRS 2-14 SIDE 56	
STAIRS 1-3 SIDE 10	12.1	15.1			15.6	15.6	15.7	15.8	12.8	6.3	11.3	13.6	13.6	13.7	13.8	13.7	13.5	11.0	STAIRS 2-15 SIDE 60	
STAIRS 1-2 SIDE 6	10.5	12.9			13.7	13.9	13.9	13.7	11.4	5.6	9.5	12.4	11.7	10.5	10.7	11.8	12.5	9.4	STAIRS 2-16 SIDE 64	
STAIRS 1-1 SIDE 2	6.4	8.5	9.3	9.6	9.5	9.2	7.0	3.5												
1.2	5'-8 1/4"																			
		Stair width - 5'8"																		
1																				

# KLIK LEDpod™ 50 Patented

## WIRING DIAGRAM Post Mounted

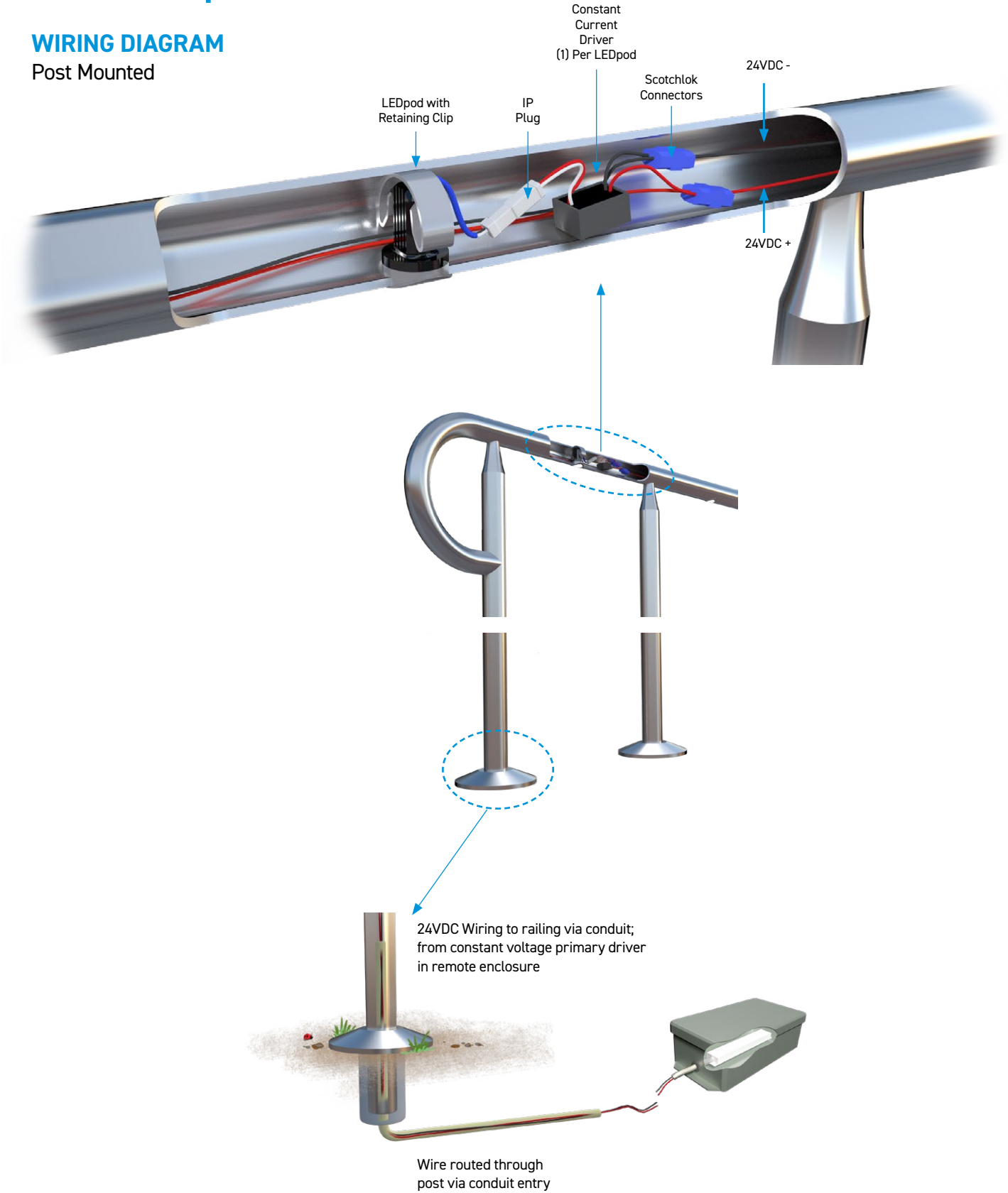

# KLIK LEDpod™ 50 Patented

## WIRING DIAGRAM

Wall Mounted

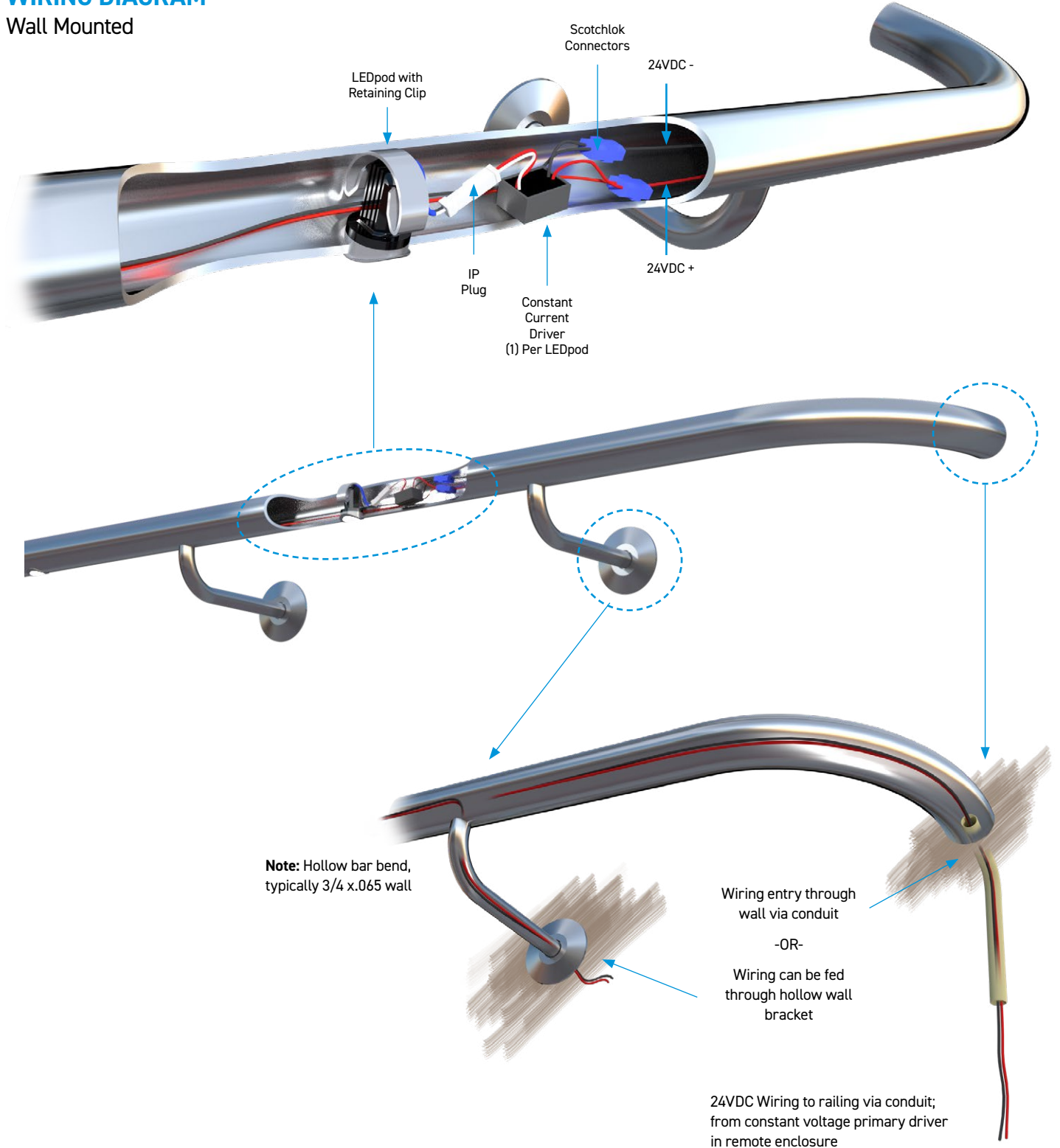

# KLIK LEDpod™ 50 Patented

## INSTALLATION INSTRUCTIONS Additional instructions may apply, consult factory.

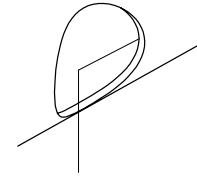
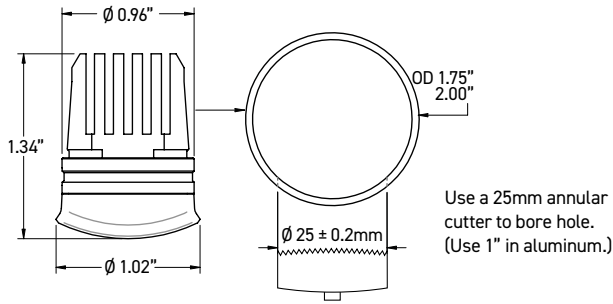

**1** Make sure drilled holes are deburred and excess chips are removed from railing.

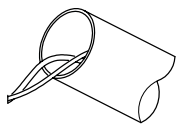

**2** Feed through appropriate wires (14ga - 18ga).

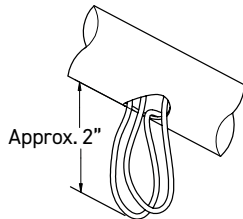

**3** Pull a loop of wire through hole.

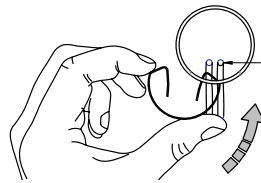

**4** Rotate retaining clips in as shown. Avoid tangling or severing through wire.



**5** Apply pressure as shown to deform clip into place in a circular motion. Avoid damaging the surface of tube and tangling or damaging wire.

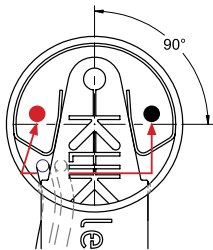

**6** Fit clip into place until the clamping ends are equally centered over the hole. Use the tool to center the clip until equal pressure can be felt and inspect by eye.

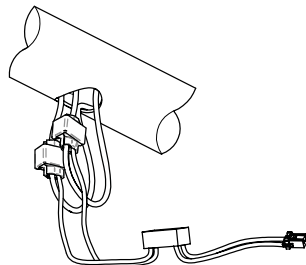

**7** Install Scotchlok connectors to the red and black wires. Connect the corresponding color wires of the driver to the Scotchloks and assure the clip is secured.

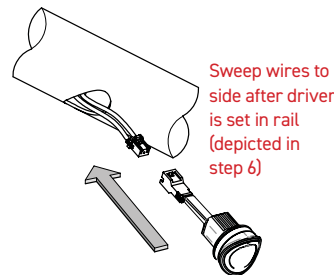

**8** CAREFULLY feed the Scotchloks to the left of the clip and the driver to the right with the driver connector hanging out. Ensure wires are clear from where the LEDPOD is to fit. Proceed to connect the LEDPOD. Install all LEDpods to this point, then perform a circuit test to ensure all LEDpods are operational BEFORE final installation.

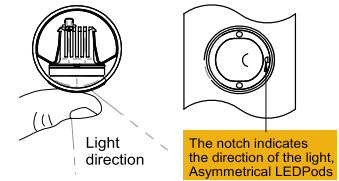

**9** Push LEDPOD in until it snaps into place and the outer surface is flush with the outer surface of the tube. Prod the rim of the clear silicone IP Seal to provide a tighter fit.

## LEDPOD REMOVAL STEPS

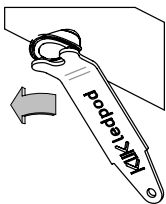

**1** Insert removal tool into the 2mm holes in the LEDPOD. With firm pressure, rotate the LEDPod 90°.

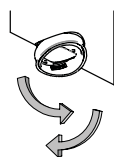

**2** Carefully peel back the IP silicone seal one side at a time.

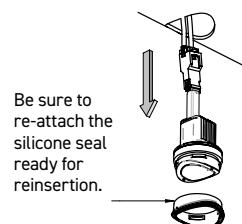

**3** Carefully remove the LEDPOD from the clip, ensuring not to damage or disconnect wires in the process. Be sure to re-attach the silicone seal ready for reinsertion.

**Application**

Recessed wall luminaire with asymmetric light distribution that is ideal for the illumination of ground surfaces, building entrances, stairs and footpaths. Separate installation housing allows for seamless coordination into construction and easy maintenance.

**Materials**

BEGA Tricoat ®, a 3-layer finishing technology for increased corrosion protection  
 Composite installation housing  
 Pure anodized aluminum reflector

**NRTL** listed to North American Standards, suitable for wet locations  
 Protection class IP 65

**Weight:** 4.0 lbs.

**Electrical**

Operating voltage 120-277V AC  
 Minimum start temperature -40° C  
 LED module wattage 12.3 W  
 System wattage 15.0 W  
 Controllability 0-10V dimmable  
 Color rendering index Ra > 90  
 Luminaire lumens 1100 lm  
 LED service life (L70) 60000 hrs

**LED color temperature**

- 4000K (K4)
- 3500K (K35)
- 3000K (K3)
- 2700K (K27)

**BEGA** can supply you with suitable LED replacement modules for up to 20 years after the purchase of LED luminaires - see website for details

**Finish**

All BEGA standard finishes are matte, textured powder coat with minimum 3 mil thickness. BEGA Unidure® finish provides superior fade protection in Black, Bronze, and Silver. BEGA standard White is a super durable polyester powder. Optionally available RAL, custom, and premium colors provided in polyester powder and/or liquid paint.

**Available colors**

- Black (BLK)
- Silver (SLV)
- Natural Bronze (NTB)
- CUS:
- Bronze (BRZ)
- White (WHT)
- RAL:

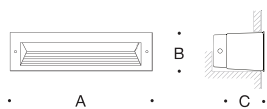

**Recessed wall luminaire · Directed light**

	LED	A	B	C
<b>B33058</b>	12.3W	13	5	5 1/2

**BEGA** 1000 BEGA Way, Carpinteria, CA 93013 (805) 684-0533 info@bega-us.com

Due to the dynamic nature of lighting products and the associated technologies, luminaire data on this sheet is subject to change at the discretion of BEGA North America. For the most current technical data, please refer to bega-us.com © copyright BEGA 2026 Updated 01/27/26

Type:

BEGA Product:

Project:

Modified:

**Available options**

- CUS Custom finish
- FSC Fusing
- MGU Marine grade undercoat
- NTB Natural bronze (premium finish)
- RAL RAL Classic, matte finish

**Included (available for pre-shipment)**

- BB24060 Installation housing



PROJECT INFORMATION		
JOB NAME		TYPE
ORDERING CODE		

# NU4

## 4" Round Downlight Standard White

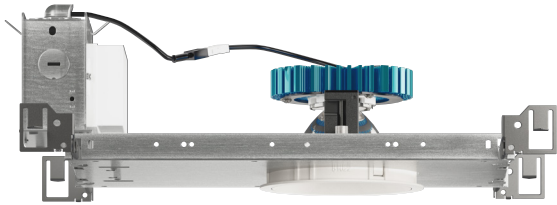

Trim

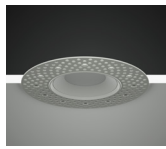

Trimless



Trimless Millwork

20° - 65° BEAM (Note: Specifications are subject to change without notice)		
14mm COB PERFORMANCE DATA		
LED LIGHT ENGINE	NOMINAL DELIVERED LUMENS	SYSTEM WATTAGE
10LM	990LM @30K/80CRI	9W
15LM	1485LM @30K/80CRI	12W
20LM	2095LM @30K/80CRI	17W
25LM	2540LM @30K/80CRI	21W
30LM	3090LM @30K/80CRI	26W
35LM	3580LM @30K/80CRI	31W
40LM	4180LM @30K/80CRI	37W
10LM	840LM @30K/90CRI	9W
15LM	1260LM @30K/90CRI	12W
20LM	1780LM @30K/90CRI	17W
25LM	2160LM @30K/90CRI	21W
30LM	2620LM @30K/90CRI	26W
35LM	3040LM @30K/90CRI	31W
40LM	3550LM @30K/90CRI	37W
Notes	Delivered lumens based on 25D optic with no lens, (see page 2)	

12° BEAM (Note: Specifications are subject to change without notice)		
10mm COB PERFORMANCE DATA		
LED LIGHT ENGINE	NOMINAL DELIVERED LUMENS	SYSTEM WATTAGE
10LM	810LM @30K/80CRI	9W
15LM	1580LM @30K/80CRI	17W
20LM	2010LM @30K/80CRI	23W
10LM	690LM @30K/90CRI	9W
15LM	1340LM @30K/90CRI	17W
20LM	1710LM @30K/90CRI	23W
Notes	Delivered lumens based on 12D optic no lens, (see page 2)	

8° BEAM (Note: Specifications are subject to change without notice)		
6mm COB PERFORMANCE DATA		
LED LIGHT ENGINE	NOMINAL DELIVERED LUMENS	SYSTEM WATTAGE
10LM	790LM @30K/80CRI	12W
15LM	1250LM @30K/80CRI	20W
10LM	670LM @30K/90CRI	12W
15LM	1060LM @30K/90CRI	20W
Notes	Delivered lumens based on 8D optic no lens, (see page 2)	

### FEATURES

- 3/4" bezel regress with 1/16" micro flange
- 8° - 110° optical beam control
- UGR < 19
- Up to 110 LPW
- Glare control, specialty optics, trim options, and custom finishes available
- Microban® antimicrobial finish available on all exposed painted surfaces

### DIMMING AND CONTROLS

- eldoLED flicker free 0-10V dimming to 0% and 1%
- eldoLED flicker free DALI dimming to 0% and 1%
- DMX dim to zero
- Lutron Hi-lume 1% 3-wire/Ecosystem
- Lutron athena wireless node
- Leading & trailing edge (Triac/ELV) dimming to 1%
- Casambi dimming to 1.0%
- NLight control interface dimming to 0%

### CONSTRUCTION

- Lexan™ (PC) highly resistant to impact and heat (240°F)
- Optimal material for wireless signal connectivity
- Shatter proof acrylic bezel lens
- Electrocoated 16-gauge cold-rolled steel construction
- Accommodates ceiling thickness from 1/8" to 1-3/4"

### LED

- 90 CRI: SDCM = 2-step MacAdam Ellipse, Lumen Maintenance: L<sub>70</sub> > 66,000 hrs
- 80 CRI: SDCM = 2-step MacAdam Ellipse, Lumen Maintenance: L<sub>70</sub> > 66,000 hrs

### LISTING

- ULus Listed to UL1598 & UL2108; cUL Listed to CSA C22.2 #250.0
- IP65 with lens - Suitable for wet locations with lens - Suitable for damp locations without lens
- Non-conductive, dead-front construction (shower approved)
- NSF/ANSI-2 with lens (Non-Food and Splash Zones)
- **Declare.** - LBC Red List Approved
- 5 Year Limited warranty

### ELECTRICAL

- 120V-277V, 120 only Triac / ELV
- Power factor ≥ 0.9
- 2kV driver input surge protection
- Remote and Integral (ITS) emergency test switch
- 7W, 10W (T20 CEC) and 12W EM 90min battery
- Max. ambient installation temperature 95°F (35°C)
- Low Voltage Luminaire option, see page 11.

### FIXTURE HEIGHT

#### 10LM - 30LM LOW LUMENS

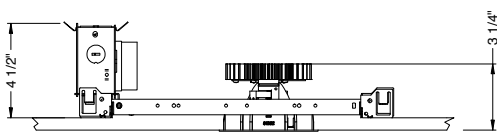

#### 35LM - 40LM HIGH LUMENS

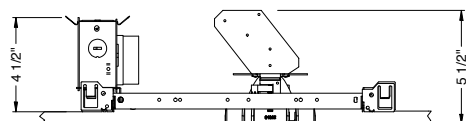

### TRIMMED



ceiling cutout  
4-3/8" diameter  
ceiling thickness  
1/8" to 1 5/8"

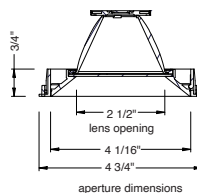

### TRIMLESS

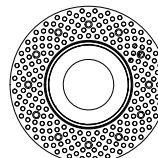

ceiling cutout  
4-1/2" diameter  
ceiling thickness  
3/8" to 1 3/4"

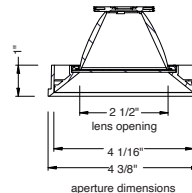

### MILLWORK



ceiling cutout  
4-3/8" diameter  
ceiling thickness  
1/2" to 1 3/4"

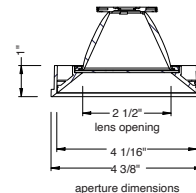

PROJECT INFORMATION		
JOB NAME		TYPE
ORDERING CODE		

ORDERING CODE	
<b>SERIES</b>	NU4 NU4
<b>TYPE</b>	RD round downlight RDT round downlight trimless RDTMW round downlight trimless millwork
<b>LED</b>	SW standard white
<b>DELIVERED LUMENS</b>	10LM 990 lm
	15LM 1485 lm
	20LM 2095 lm
	25LM 2540 lm
	30LM 3090 lm
	35LM 3580 lm
	40LM 4180 lm
Standard Configuration: 3000K 80CRI 25D, NL Calculated Delivered Lumens = [Delivered Lumen Value] x [CCT Multiplier] x [Reflector Multiplier]	
<b>CCT</b>	27K 2700K
	30K 3000K
	35K 3500K
	40K 4000K
<b>CRI</b>	80 80 CRI
	90 90 CRI
<b>OPTIC &amp; LM MULTIPLIER</b> SEE PAGE 5, 6	8D <sup>1</sup> 8 degrees (1.00)
	12D <sup>1</sup> 12 degrees (1.00)
	20D 20 degrees (0.99)
	25D 25 degrees (1.00)
	35D 35 degrees (0.99)
	50D 50 degrees (0.99)
	65D 65 degrees (0.99)
<b>BEZEL LENS</b> SEE PAGE 3	NL <sup>2</sup> no lens (1.00)
	CL clear lens (0.98)
	DL diffused lens (0.91)
	E <sup>3</sup> elliptical beam spread (0.92)
	HCL <sup>4</sup> honeycomb louver (0.85)
	HET high efficiency textured lens, similar to Solite™ (0.92)
	SBL smoothing beam lens (0.92)
WDL wide diffused lens* (0.90)	
*Wide diffusing lens achieves beams ≥ 90° see page 4	
<b>TRIM COLOR</b> SEE PAGE 3	BK black
	WH white
	MC matte chrome
	BZ bronze
	WT wheat
CC <sup>5</sup> custom color, consult factory for details	
Antimicrobial finish, add AM to black, white or matte chrome i.e. BKAM.	
Not applicable to trimless option. Do not include in trimless ordering code.	
<b>BEZEL COLOR</b> SEE PAGE 3	BK black (0.98)
	WH white (1.00)
	MC matte chrome (0.99)
	BZ bronze (0.98)
	WT wheat (0.99)
CC <sup>5</sup> custom color, consult factory for details	
Antimicrobial finish, add AM to black, white or matte chrome i.e. BKAM.	

ORDERING CODE	
<b>MOUNTING OPTIONS</b> SEE PAGE 8, 9	NC new construction plate
	IC <sup>6</sup> insulation contact housing
	ICAT <sup>6</sup> insulation contact/airtight housing
	CP <sup>6</sup> chicago plenum housing
RET retrofit, no ceiling plate	
<b>VOLTAGE</b>	120 120V
	UNV 120V-277V
	LVL <sup>7</sup> low voltage luminaire
<b>DIMMING</b>	DIM10 eldoLED flicker free 0-10V dim to 1%
	DIM10Z eldoLED flicker free 0-10V dim 0.1%
	DALI eldoLED flicker free DALI-2 dim to 1%
	DALIZ eldoLED flicker free DALI-2 dim to 0.1%
	DMX-RJ45 DMX control dimming to 0.1% with RJ45 connection
	DMX-WL DMX-512/RDM dim to 0% with XLR input
	DMX-XLR DMX-512/RDM dim to 0% with lead wire input
	LUT Lutron Hi-lume Ecosystem dimming to 1%, Soft-on & Fade-to-Black
	LUTP <sup>8</sup> Lutron Hi-Lume Eco (fade) dim to 0.1%
	ELVI <sup>9</sup> leading edge & trailing edge (Triac/ELV) dim to 1%
	NLT nLight control interface: Cat-5/RJ45, dim to off
	CAS Casambi control with flicker free 1% dimming
	AWN <sup>10</sup> lutron athena wireless node
	L3DA Lutron Hi-lume 1% 3-wire/Ecosystem
ND No Driver Included. Customer to supply PoE system components or order remote driver separately. Refer to PoE/Remote Driver reference sheet for additional details.	
<b>ELECTRICAL OPTIONS</b>	EM7 <sup>11</sup> remote emergency battery, 90 min at 7W
	EM12 <sup>11</sup> remote emergency battery, 90 min at 12W
	EM10CA20 <sup>11</sup> remote emergency battery, 90 min at 10W

ADDITIONAL MOUNTING INFO	
New Construction Bar Hangers (included)	Mounting Length: 14-3/4" to 26"
Extension Kit p/n: K20266 (ordered separately, 1 per fixture)	Extends a pair of Bar Hangers Total Mounting Length: 29" to 48"

YOUR COMPLETED ORDERING CODE
Follow the steps to specify your fixture, example:
<b>NU4 - RD - SW - 20LM - 35K - 90 - 8D - NL - WH - WH - NC - UNV - DIM10 - EM7</b>

### NOTES

- 8D available in 10LM/15LM and 12D available in 10LM/15LM/20LM. Not recommended with DL/E/WDL lenses, beam angel increases by 25% or 2.5x.
- NL option does not meet requirements for AT/DF/WET/NSF listings. Lensing cannot be added in the field.
- Elliptical lens not available with 8D/12D optic options. Actual beam distributions [20D= 35° x 60°, 25D= 40° x 65°, 35D= 45° x 70°, 55D= 55° x 80°]
- HCL not available with lens.
- Custom set up fee plus minimum quantity required per color.
- IC/ICAT/CP not available in 40LM.
- Must select ND dimming code, for remote driver or POE specifications see page 11.
- LUTP not available in 25LM/30LM/40LM.
- ELVI available in 120V.
- AWN<sup>10</sup> reference page 11 for product specifications on Athena wireless node.
- For integrated test switch add "ITS" after emergency backup code, i.e. EM12ITS. Not available in LVL/ND voltage and dimming codes.

\* EldoLED and DMX uses logarithmic dimming curve as standard. For linear dimming curve, add "LIN" after dimming code, i.e. DIM10LIN.

PROJECT INFORMATION		
JOB NAME		TYPE
ORDERING CODE		

## TRIM OPTIONS

### TRIM/BEZEL COLORS



## OPTICAL OPTIONS

- UGR calculation based on CIE 117-1995; room size: 4H X 8H, reflectance: 70/50/20;
- UGR calculation based on 15LM fixtures, unless otherwise noted.

### REFLECTOR OPTIC ACCESSORY Honeycomb Louver



OPTIC	BEAM ANGLE	UGR
8D	7.8	10.9
12D	11.3	23.5
20D	17.4	12.5
25D	22.2	13.9
35D	32.4	16.5
50D	44.9	13.4
65D	52	15.5

### NL No Lens



OPTIC	BEAM ANGLE	UGR
8D	7.8	14.2
12D	11.9	13.8
20D	18	13.6
25D	22.8	13.1
35D	36.2	14.5
50D	49.2	18.3
65D	64.5	18.8

### CL Clear Lens



OPTIC	BEAM ANGLE	UGR
8D	7.9	13.7
12D	12.1	13.3
20D	18	13.3
25D	22.8	12.8
35D	36.2	14.2
50D	49.2	18.1
65D	64.6	18.5

### SBL Smoothing Beam Lens



OPTIC	BEAM ANGLE	UGR
8D	10.2	12.8
12D	13.2	12.9
20D	19.3	13
25D	24.3	13.1
35D	37.2	14.8
50D	51.2	15.6
65D	62.2	18.8

### HET High Efficiency Textured Lens



OPTIC	BEAM ANGLE	UGR
20D	22.5	13.8
25D	27	14
35D	38.8	15.8
50D	49.8	16.5
65D	60.4	19.5

### DL Diffused Lens



OPTIC	BEAM ANGLE	UGR
20D	39.4	19.5
25D	42.4	19.8
35D	50.6	20.8
50D	56.7	21.4
65D	66.7	23.3

### WDL Wide Diffused Lens



OPTIC	BEAM ANGLE	UGR
20D	90.5	19.5
25D	93	19.8
35D	100	20.8
50D	104.5	21.4
65D	110.5	23.3

## GLARE CONTROL

### CUT-OFF ANGLE

Visual comfort is achieved with a lower cut-off angle due to improved glare control. The smaller the cut-off angle, the easier it is on the eye.

Alphabet downlights have been thoughtfully engineered to eliminate glare while still delivering functional illumination.

- Cutoff angle of CL is 35 degrees;

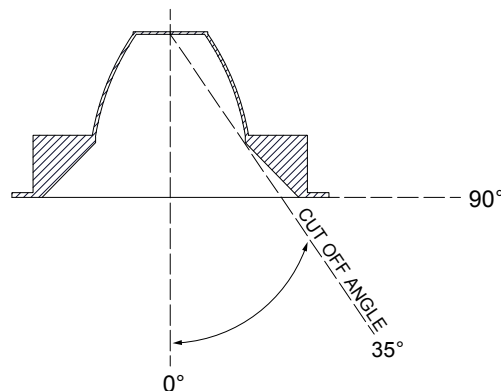

PROJECT INFORMATION		
JOB NAME		TYPE
ORDERING CODE		

## TRIM OPTIONS

### TRIM/BEZEL COLORS



## OPTICAL OPTIONS

- UGR calculation based on CIE 117-1995; room size: 4H X 8H, reflectance: 70/50/20;
- UGR calculation based on 15LM fixtures, unless otherwise noted.

### AMBER

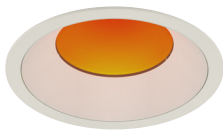

OPTIC	MULTIPLIER	BEAM SPREAD
20D	0.485	18°
25D	0.484	22°
35D	0.485	35°
50D	0.48	50°
65D	0.473	60°

AVERAGE LUMENS: 2000LM 1880 CCT

### RED



OPTIC	MULTIPLIER	BEAM SPREAD
20D	0.04	18°
25D	0.04	22°
35D	0.04	35°
50D	0.04	50°
65D	0.038	60°

AVERAGE LUMENS: 168LM

### GREEN

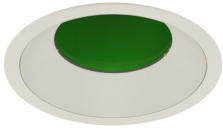

OPTIC	MULTIPLIER	BEAM SPREAD
20D	0.202	18°
25D	0.202	22°
35D	0.204	35°
50D	0.2	50°
65D	0.196	60°

AVERAGE LUMENS: 850LM

### BLUE

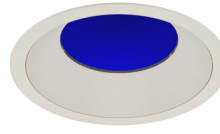

OPTIC	MULTIPLIER	BEAM SPREAD
20D	0.051	18°
25D	0.051	22°
35D	0.053	35°
50D	0.05	50°
65D	0.049	60°

AVERAGE LUMENS: 210LM

Add AM / BL / GR / RD to bezel lens ordering code section.

Example: NU4 - RD - SW - 10LM - 30K - 80 - 35D - <b>BL</b> - WH - WH - NC - UNV - DIM

PROJECT INFORMATION		
JOB NAME		TYPE
ORDERING CODE		

## PHOTOMETRIC DATA

### 20LM CCT MULTIPLIERS

	80CRI	90CRI
2700K	0.96	0.81
3000K	1	0.85
3500K	1.03	0.88
4000K	1.06	0.91

FC Formula = CBCP / Distance<sup>2</sup>

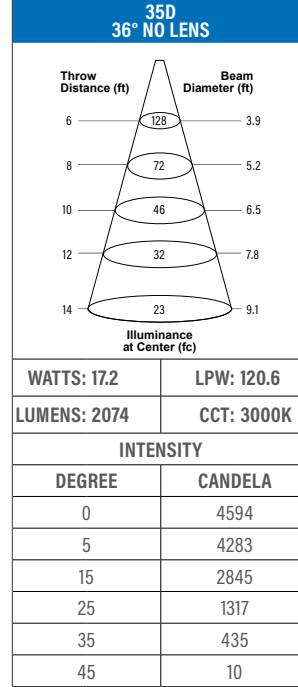
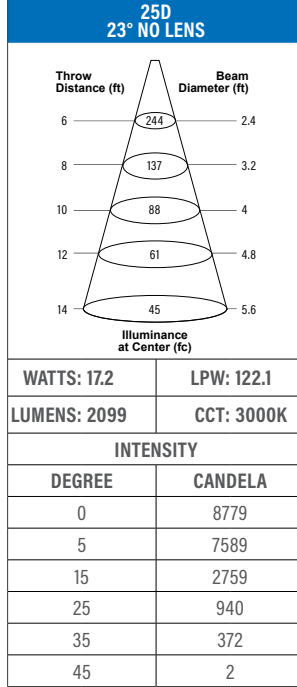
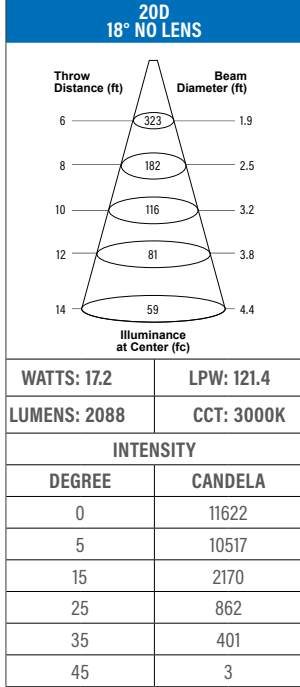

### 40LM CCT MULTIPLIERS

	80CRI	90CRI
2700K	0.96	0.81
3000K	1	0.85
3500K	1.03	0.88
4000K	1.06	0.91

FC Formula = CBCP / Distance<sup>2</sup>

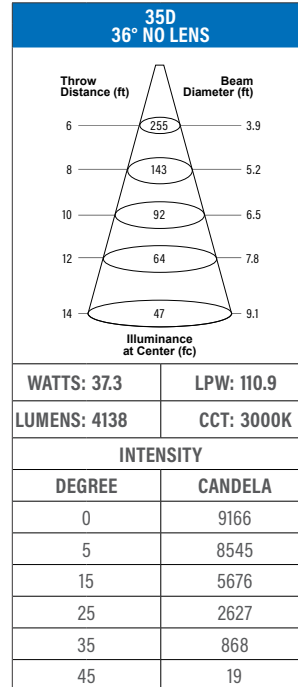
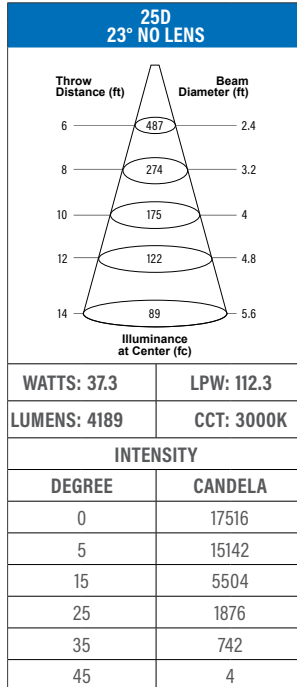
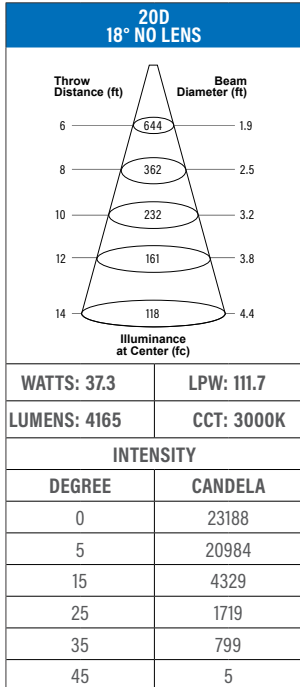

PROJECT INFORMATION		
JOB NAME		TYPE
ORDERING CODE		

## PHOTOMETRIC DATA

20LM CCT MULTIPLIERS		
	80CRI	90CRI
2700K	0.96	0.81
3000K	1	0.85
3500K	1.03	0.88
4000K	1.06	0.91
FC Formula = CBCP / Distance <sup>2</sup>		

50D 49° NO LENS	
Throw Distance (ft)	Beam Diameter (ft)
6	9.0
8	5.1
10	3.3
12	2.3
14	1.7
Illuminance at Center (fc)	
WATTS: 17.2	LPW: 121.2
LUMENS: 2085	CCT: 3000K
INTENSITY	
DEGREE	CANDELA
0	3253
5	3231
15	2606
25	1591
35	450
45	13

65D 65° NO LENS	
Throw Distance (ft)	Beam Diameter (ft)
6	5.9
8	3.3
10	2.1
12	1.5
14	1.1
Illuminance at Center (fc)	
WATTS: 17.2	LPW: 120.9
LUMENS: 2080	CCT: 3000K
INTENSITY	
DEGREE	CANDELA
0	2103
5	2101
15	1990
25	1520
35	779
45	144

40LM CCT MULTIPLIERS		
	80CRI	90CRI
2700K	0.96	0.81
3000K	1	0.85
3500K	1.03	0.88
4000K	1.06	0.91
FC Formula = CBCP / Distance <sup>2</sup>		

50D 49° NO LENS	
Throw Distance (ft)	Beam Diameter (ft)
6	180
8	102
10	65
12	45
14	33
Illuminance at Center (fc)	
WATTS: 37.3	LPW: 111.5
LUMENS: 4160	CCT: 3000K
INTENSITY	
DEGREE	CANDELA
0	6491
5	6446
15	5200
25	3175
35	898
45	25

65D 65° NO LENS	
Throw Distance (ft)	Beam Diameter (ft)
6	117
8	66
10	42
12	29
14	21
Illuminance at Center (fc)	
WATTS: 37.3	LPW: 111.2
LUMENS: 4150	CCT: 3000K
INTENSITY	
DEGREE	CANDELA
0	4195
5	4191
15	3971
25	3033
35	1555
45	288

PROJECT INFORMATION		
JOB NAME		TYPE
ORDERING CODE		

## PHOTOMETRIC DATA

10LM CCT MULTIPLIERS		
	80CRI	90CRI
2700K	0.96	0.81
3000K	1	0.85
3500K	1.03	0.88
4000K	1.06	0.91
FC Formula = CBCP / Distance <sup>2</sup>		

8D 7.8° NO LENS	
Throw Distance (ft)	Beam Diameter (ft)
6	562
8	316
10	202
12	140
14	103
Illuminance at Center (fc)	
WATTS: 12	LPW: 66
LUMENS: 792	CCT: 3000K
INTENSITY	
DEGREE	CANDELA
0	20223
5	6477
15	368
25	287
35	170
45	0

12D 12° NO LENS	
Throw Distance (ft)	Beam Diameter (ft)
6	266
8	150
10	96
12	66
14	49
Illuminance at Center (fc)	
WATTS: 8.7	LPW: 92.8
LUMENS: 807	CCT: 3000K
INTENSITY	
DEGREE	CANDELA
0	9574
5	6065
15	532
25	299
35	155
45	0

20LM CCT MULTIPLIERS		
	80CRI	90CRI
2700K	0.96	0.81
3000K	1	0.85
3500K	1.03	0.88
4000K	1.06	0.91
FC Formula = CBCP / Distance <sup>2</sup>		

8D 7.8° NO LENS	
Throw Distance (ft)	Beam Diameter (ft)
6	885
8	498
10	319
12	221
14	163
Illuminance at Center (fc)	
WATTS: 20	LPW: 62.4
LUMENS: 1248	CCT: 3000K
INTENSITY	
DEGREE	CANDELA
0	31866
5	10206
15	579
25	452
35	269
45	1

12D 12° NO LENS	
Throw Distance (ft)	Beam Diameter (ft)
6	520
8	293
10	187
12	130
14	96
Illuminance at Center (fc)	
WATTS: 17	LPW: 92.9
LUMENS: 1579	CCT: 3000K
INTENSITY	
DEGREE	CANDELA
0	18725
5	11861
15	1041
25	585
35	303
45	0

PROJECT INFORMATION		
JOB NAME		TYPE
ORDERING CODE		

## MOUNTING OPTIONS

### FIXTURE HEIGHT

#### 10M - 30LM CONFIGURATION

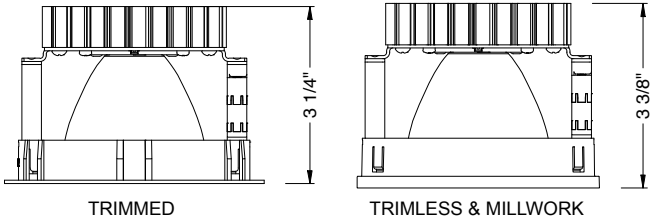

#### 35M - 40LM CONFIGURATION

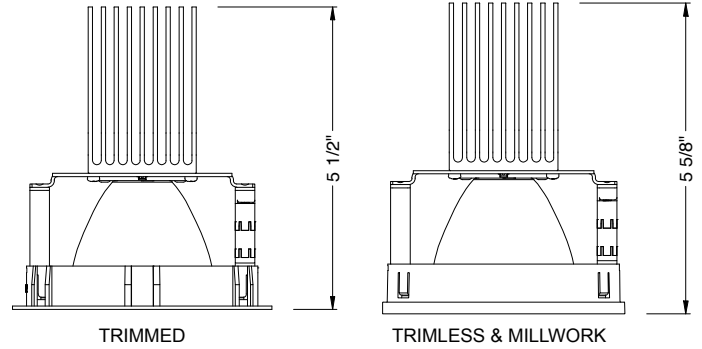

### NC - NEW CONSTRUCTION

#### TRIM

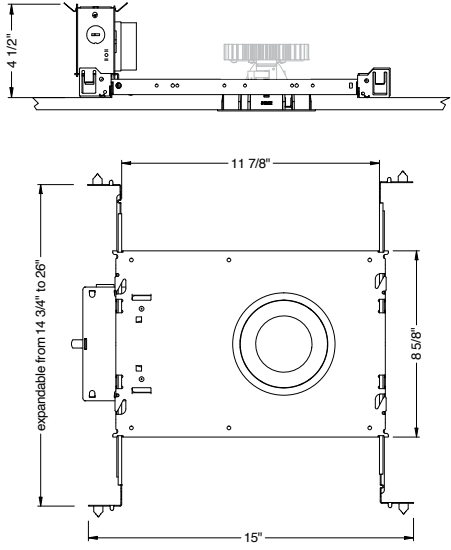

#### TRIM

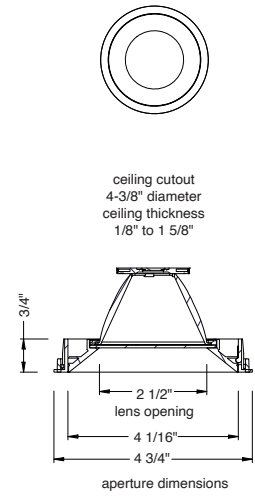

#### TRIMLESS

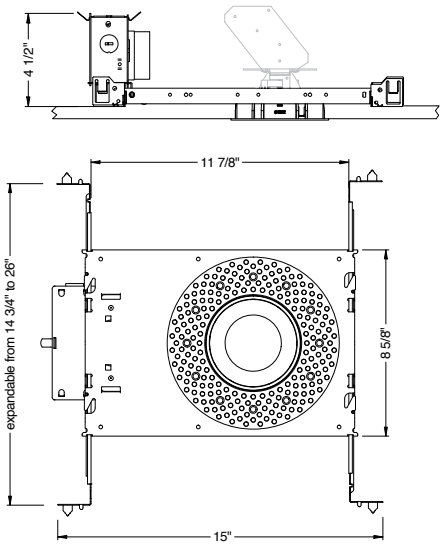

#### TRIMLESS

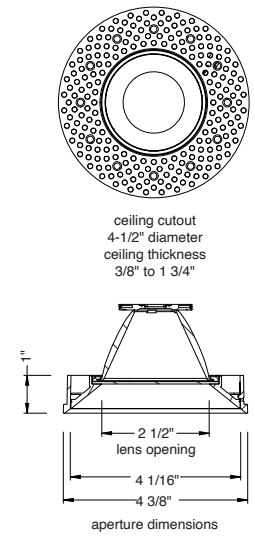

#### TRIMLESS/MILLWORK

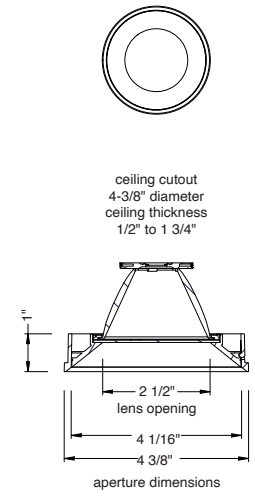

PROJECT INFORMATION		
JOB NAME		TYPE
ORDERING CODE		

## MOUNTING OPTIONS (CONTINUED)

### RET - RETRO TRIM/TRIMLESS

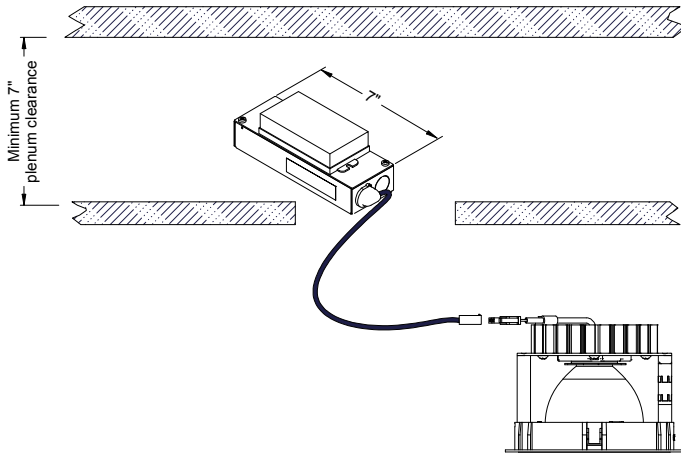

### IC - INSULATION CONTACT HOUSING ICAT - INSULATION CONTACT / AIR TIGHT CP - CHICAGO PLENUM

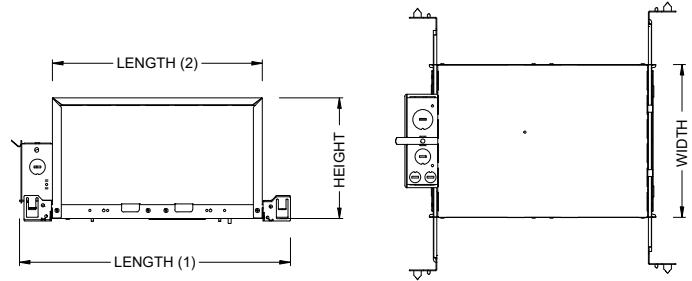

BOX SIZE	L 1	L 2	W	H
A	15 - 7/16"	11 - 3/4"	8 - 1/2"	6 - 3/4"
B	18 - 1/4"	14 - 7/8"	12 - 1/8"	11 - 1/4"

RATINGS / CERTIFICATIONS	NC	RET	IC	ICAT	CP
TYPE NON-IC	✓	✓			
TYPE IC			✓	✓	✓
CHICAGO PLENUM (CCEA)					✓
SUITABLE FOR AIR HANDLING PLENUMS	✓	✓	✓	✓	✓
REDUCED AIRFLOW (WITH LENS) ASTM E283	✓	✓	✓	✓	✓

BOX TYPE / LUMEN OUTPUT - NARROW BEAM (8°-12°)						
LUMEN OUTPUT	BOX - A			BOX - B		
	IC	ICAT	CP	IC	ICAT	CP
10LM	✓	✓	✓			
15LM	✓	✓	✓			
20LM				✓	✓	✓

CEILING THICKNESS	
FIXTURE TYPE	MOUNTING TYPE
	STANDARD CEILING THICKNESS
TRIM	1/8" to 1-5/8"
TRIMLESS	3/8" to 1-3/4"
MILLWORK (TRIMLESS)	1/2" to 1-3/4"

BOX TYPE / LUMEN OUTPUT - STANDARD BEAMS (20° - 65°)						
LUMEN OUTPUT	BOX - A			BOX - B		
	IC	ICAT	CP	IC	ICAT	CP
10LM	✓	✓	✓			
15LM	✓	✓	✓			
20LM	✓	✓	✓			
25LM	✓	✓	✓			
30LM	✓	✓	✓			
35LM				✓	✓	✓
40LM						

PROJECT INFORMATION		
JOB NAME	TYPE	
ORDERING CODE		

## BATTERY OPTIONS

### EMERGENCY BATTERY

IOTA's ILB Battery Backups are UL Listed LED emergency drivers that allow the same LED fixture to be used for both normal and emergency operation. In the event of a power failure, the ILB switches to the emergency mode and operates the existing fixture for 90 minutes. The unit contains a battery, charger, and converter circuit in a single can. The Constant Power design of the ILB maintains the output wattage to the LED array even as the system voltage diminishes. UL 924 Listed for U.S. and Canada. UL 1310 Certified, Output Class 2 Compliant. Includes single-piece TBTS test switch and charge indicator accessory kit. For use with switched and unswitched fixtures, and includes Two-wire universal AC input. Meets or exceeds all National Electric Code and Life Safety Code Emergency Lighting Requirements. Rated for use in Plenum, Damp Location, Recessed Type IC, and Enclosed and Gasketed Luminaires.

### INTEGRATED TEST SWITCH

The integrated test switch mounted onto fixture bezel.

### REMOTE TEST SWITCH

The Remote Test Switch may be mounted adjacent to the LED Fixture by others.

### EMERGENCY BATTERY ACCESS

Above ceiling access is required for service. An access panel in the ceiling (or other form of access) adjacent to the installation location of the Emergency Battery is required.

### REMOTE LOCATION

Maximum remote mounting distance of the emergency driver shall be 50 feet. Remote location wiring provided by others. Follow all Local and National Electric/ Building Codes.

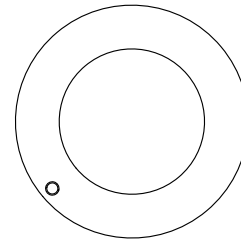

Integrated Test Switch

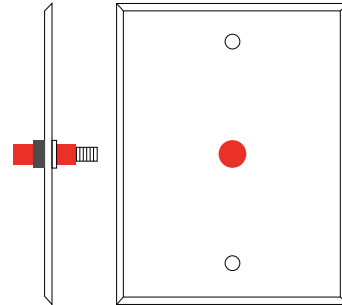

Remote Test Switch

### EM MODE OUTPUT (DELIVERED LUMENS)

LUMEN ORDERING CODE	EM7	EM10	EM12
ALL OPTIONS (10LM TO 30LM)	820LM	1200LM	1480LM

Notes: Based on 30K, 80CRI

### NC - NEW CONSTRUCTION WITH EM BATTERY (REMOTE TEST SWITCH)

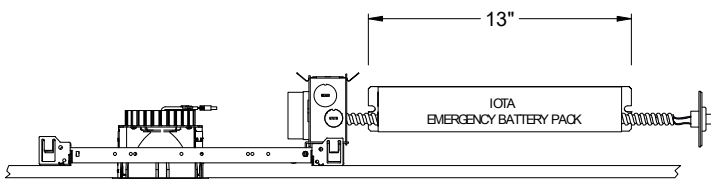

### IC / ICAT / CP - INSULATION CONTACT HOUSING WITH EM BATTERY (REMOTE TEST SWITCH)

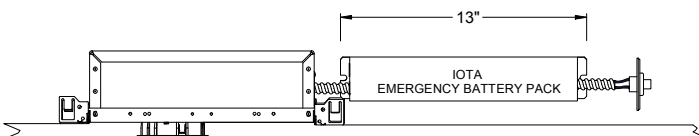

### RET - RETROFIT WITH EM BATTERY (REMOTE TEST SWITCH)

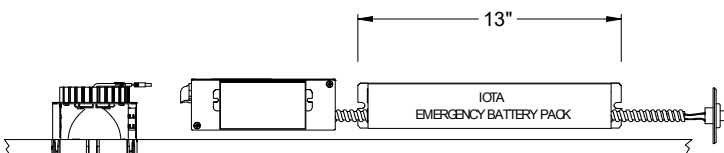

### Accessory

76066 Optional T-Grid Mounting Kit<sup>1</sup>

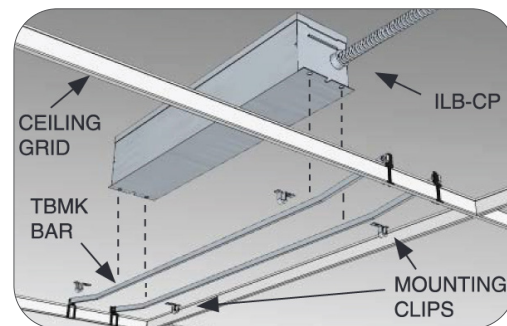

1. Can be used with any of the Emergency Battery Backups. Must be ordered as a separate line item.

PROJECT INFORMATION			
JOB NAME		TYPE	
ORDERING CODE			

## LOW VOLTAGE OPTIONS

20° - 65° BEAM (Note: Specifications are subject to change without notice)			
14mm COB PERFORMANCE DATA			
LED LIGHT ENGINE	NOMINAL DELIVERED LUMENS	DRIVE CURRENT	LED WATTAGE
10LM	990LM @30K/80CRI	250mA	9W
15LM	1485LM @30K/80CRI	300mA	11W
20LM	2095LM @30K/80CRI	425mA	15.5W
25LM	2540LM @30K/80CRI	525mA	19W
30LM	3090LM @30K/80CRI	650mA	23.5W
35LM	3580LM @30K/80CRI	800mA	29W
40LM	4180LM @30K/80CRI	900mA	32.5W
10LM	840LM @30K/90/CRI	250mA	9W
15LM	1260LM @30K/90/CRI	300mA	11W
20LM	1780LM @30K/90/CRI	425mA	15.5W
25LM	2160LM @30K/90/CRI	525mA	19W
30LM	2620LM @30K/90/CRI	650mA	23.5W
35LM	3040LM @30K/90/CRI	800mA	29W
40LM	3550LM @30K/90/CRI	900mA	32.5W
Notes	Delivered lumens based on 25D optic with no lens, (see page 2)		

12° BEAM (Note: Specifications are subject to change without notice)			
10mm COB PERFORMANCE DATA			
LED LIGHT ENGINE	NOMINAL DELIVERED LUMENS	DRIVE CURRENT	LED WATTAGE
10LM	810LM @30K/80CRI	250mA	9W
15LM	1580LM @30K/80CRI	300mA	11W
20LM	2010LM @30K/80CRI	400mA	14.5W
10LM	690LM @30K/90CRI	250mA	9W
15LM	1340LM @30K/90CRI	300mA	11W
20LM	1710LM @30K/90CRI	400mA	14.5W
Notes	Delivered lumens based on 12D optic no lens, (see page 2)		

8° BEAM (Note: Specifications are subject to change without notice)			
6mm COB PERFORMANCE DATA			
LED LIGHT ENGINE	NOMINAL DELIVERED LUMENS	DRIVE CURRENT	LED WATTAGE
10LM	790LM @30K/80CRI	225mA	8.5W
15LM	1250LM @30K/80CRI	350mA	13W
10LM	670LM @30K/90CRI	225mA	8.5W
15LM	1060LM @30K/90CRI	350mA	13W
Notes	Delivered lumens based on 8D optic no lens, (see page 2)		

## NOMINAL LED VOLTAGE: 36VDC

Customer to order CC Remote Driver separately or POE Node by others.

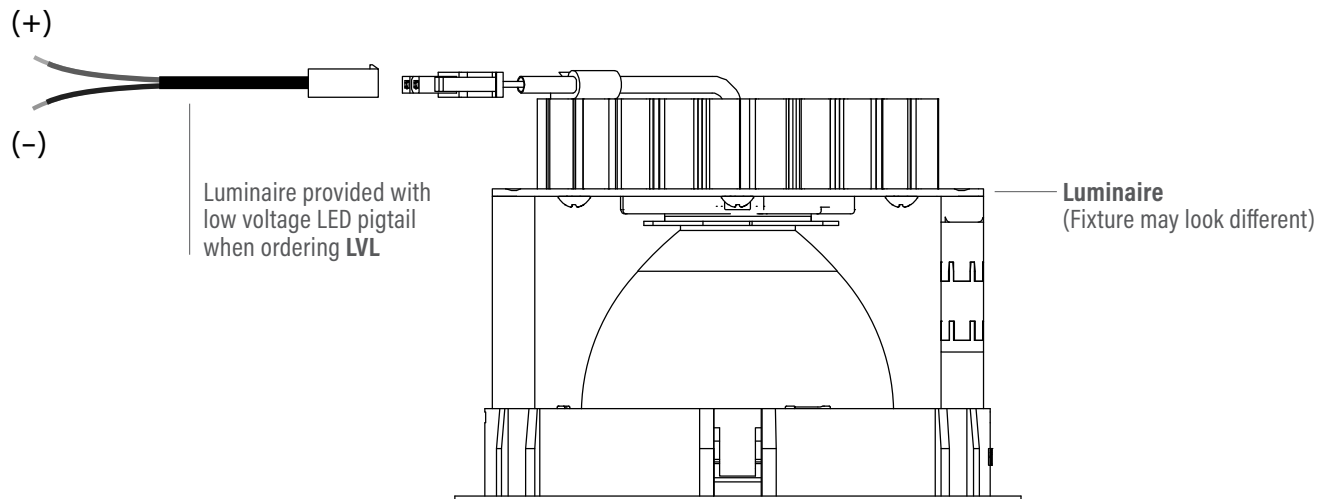

PROJECT INFORMATION		
JOB NAME	TYPE	
ORDERING CODE		

## AWNRR OPTIONS

### Athena Wireless Node

The Athena wireless node is a radio frequency (RF) device that enables simple, digital control of individual light fixtures in an Athena control system.

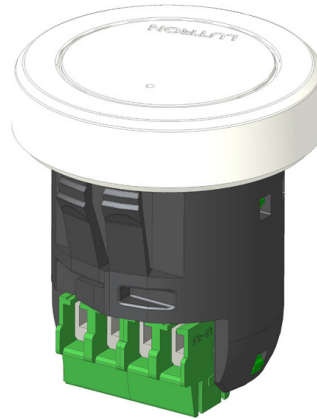

Athena Wireless Node RF

#### AWNRR

Plenum rated and can be installed above the ceiling for wireless control of a fixture without any impact on fixture aesthetics.

#### FEATURES

- Enables individual, wireless control of each fixture in an Athena control system. Accommodates zone and control changes without rewiring.
- Installed at factory – no wiring required on-site. Fixture is ready to communicate wirelessly once power is connected.
- All drivers on the link are controlled as a single zone.

#### REGULATORY APPROVALS

- cULus Listed (UL916)
- Complies with requirements for use in other spaces used for environmental air (plenums) per NEC® 2014 300.22(C)(3).
- FCC compliant with the limits for a Class B digital device.
- IC (Industry Canada)
- ANSI C137.1 0-10 V- Electronic Off

#### POWER / LOAD

- IEC SELV/NEC® Class 2
- 1 Watt

#### ENVIRONMENTAL

- Ambient operating temperature (immediate vicinity of Athena wireless node): **32 °F to 131 °F** (0 °C to 55 °C), 0% to 90% humidity.

#### BATTERY OPTIONS

- For EM options please consult factory.

#### Note: Default behavior prior to programming

- Light level 100%
- Athena wireless node performs an unprogrammed startup sequence on every power up until the device is added to an Athena system.
- Each Athena wireless node should be installed within 25 ft (7.62 m) of two or more Athena wireless nodes or other Clear Connect – Type X devices.
- For Chicago plenum installations, the Athena wireless node may not be installed in the plenum space. It must be installed in the occupied space.

**For servicing the driver/j-box, access above ceiling is required. (NC Mounting)**

**IC/ICAT/CP not available in AWNR.**

#### NC - NEW CONSTRUCTION

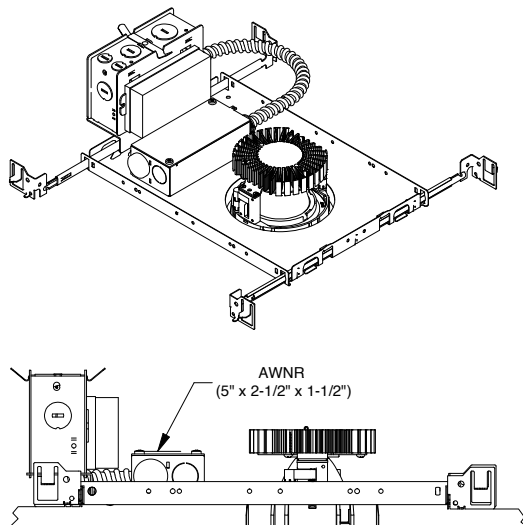

#### RET - RETRO FIT

