



# Hydraulic Impact Analysis Supplemental Memorandum

Multnomah County | Earthquake Ready  
Burnside Bridge Project

*Portland, OR*

April 22, 2022





# Earthquake Ready Burnside Bridge Hydraulic Impact Analysis Supplemental Memorandum

*Prepared for*

**Multnomah County**  
**Transportation Division – Bridges**  
1403 SE Water Ave  
Portland, OR 97214

*Prepared by*

**HDR**  
1050 SW 6th Ave, Suite 1800  
Portland, OR 97204  
T (503) 423-3700

**Parametrix**  
700 NE Multnomah St, Suite 1000  
Portland, OR 97232  
T (503) 233-2400

Contract# DCS-SVCSGEN-857-2019-conv  
HDR Project #10144814



## Contents

Executive Summary .....	1
1 Introduction.....	1
1.1 Project Location.....	2
1.2 Project Purpose.....	2
2 Project Alternatives .....	4
3 Definitions.....	5
4 Relevant Regulations .....	7
5 Analysis Methodology .....	7
6 Affected Environment.....	7
7 Impacts from the Design Modifications and Comparison to Draft EIS Alternatives .....	8
7.1 Pre-Earthquake Impacts.....	8
7.1.1 No-Build Alternative.....	8
7.1.2 Impacts Common to all Build Alternatives.....	8
7.1.3 Draft EIS Replacement Alternative with Long-Span Approach.....	11
7.1.4 Refined Alternative with Long-Span Approach .....	11
7.2 Post-Earthquake Impacts.....	12
7.3 Construction Impacts.....	12
7.3.1 Impacts Common to All Alternatives .....	12
7.3.2 With Temporary Work Bridge .....	13
7.4 Cumulative Effects .....	14
7.5 Compliance with Laws, Regulations, and Standards.....	15
7.6 Conclusion.....	15
8 Potential Mitigation .....	16
9 Agency Coordination .....	16
10 Preparers.....	16
11 References .....	17

## Tables

Table 1. Estimated Floodway Encroachment .....	9
Table 2. Estimated Percent Change in Scour Length <sup>a</sup> .....	10
Table 3. API Floodplain Encroachment (Outside of the Floodway).....	10
Table 4. Estimated Temporary Floodway Encroachment.....	13

## Figures

Figure 1. Project Area .....	3
------------------------------	---

## Appendices

Appendix A. Preliminary Hydraulic Impact Estimates .....A-1

## Acronyms, Initialisms, and Abbreviations

ADA	Americans with Disabilities Act
API	Area of Potential Impact
FEMA	Federal Emergency Management Agency

*This page is intentionally left blank.*



# Executive Summary

This supplemental memorandum evaluates potential design refinements to the Replacement Alternative with Long-Span Approach (Long-span Alternative) that was evaluated in the EQRB Draft EIS. The Draft EIS evaluated a No-Build Alternative and four Build Alternatives; the Long-span Alternative was identified as the Preferred Alternative through this process. The potential design refinements that were considered for this supplemental hydraulic impact analysis include a narrower bridge width, which would allow narrower in-water piers, and a refined Americans with Disabilities Act access option that includes elevators and stairs for pedestrian and bicycle access. Potential changes to in-water work activity include removing the existing piers (except for Pier 1) to below the mudline, removing the in-water piles, and raising the replacement bridge in-water foundations, which limits the need for cofferdams to an elevation about mid-height of the river.

As stated in the *EQRB Hydraulic Impact Analysis Technical Report* (Multnomah County 2021c), all Build Alternatives' pier designs are anticipated to create some degree of hydraulic encroachment and result in an increase in the base flood elevation, as well as an increased scour potential. The Refined Long-span Alternatives would have less potential for increasing the base flood elevation compared to the Draft EIS Long-span Alternatives, and the vertical lift option would have the lowest potential among the refined lift configurations. The Refined Long-span Alternatives would have longer footings in the direction of the flow which could increase the potential for pier scour as compared to the Draft EIS Long-Span and No-Build Alternatives. The Draft EIS Long-span and Refined Long-span Alternatives would be expected to have a similar effect on floodplain encroachment resulting from the placement of shafts in the 500-year floodplain outside the mapped floodway. Detailed modeling analysis would be performed to support the Final EIS and to avoid or minimize these impacts through design refinements. If impacts could not be avoided through design, the Project would coordinate with the City to comply with floodplain impact regulations and scour prevention and monitoring measures and acquire federal approval of the impact.

## 1 Introduction

In support of the Supplemental Draft Environmental Impact Statement (SDEIS) for the Earthquake Ready Burnside Bridge (EQRB) Project, this supplemental technical memorandum has been prepared to evaluate the impacts of potential design refinements to the Preferred Alternative on river and floodplain hydraulics within the project's Area of Potential Impact (API). The intent of the design modifications is to reduce the overall cost and improve the affordability of the EQRB Project. This technical memorandum is a supplement to the Draft EIS technical reports and as such does not repeat all of the information in those reports, but instead focuses on the impacts of the design modification options, how they compare to each other, and how they compare to the version of the Preferred Alternative that was evaluated in the EQRB Draft EIS.

Much of the information included in the Draft EIS and Draft EIS technical reports, including project purpose, relevant regulations, analysis methodology, and affected environment, is incorporated by reference because it has not changed, except where noted in this technical memorandum.

## 1.1 Project Location

The Project Area is located within the central city of Portland. The Burnside Bridge crosses the Willamette River connecting the west and east sides of the city. The Project Area encompasses a one-block radius around the existing Burnside Bridge and W/E Burnside Street, from NW/SW 3rd Avenue on the west side of the river and NE/SE Grand Avenue on the east side. Several neighborhoods surround the area including Old Town/Chinatown, Downtown, Kerns, and Buckman. Figure 1 shows the Project Area.

## 1.2 Project Purpose

The primary purpose of the Project is to build a seismically resilient Burnside Street lifeline crossing over the Willamette River that will remain fully operational and accessible for vehicles and other modes of transportation following a major Cascadia Subduction Zone earthquake. The Burnside Bridge will provide a reliable crossing for emergency response, evacuation, and economic recovery after an earthquake. Additionally, the bridge will provide a long-term safe crossing with low-maintenance needs.

Figure 1. Project Area

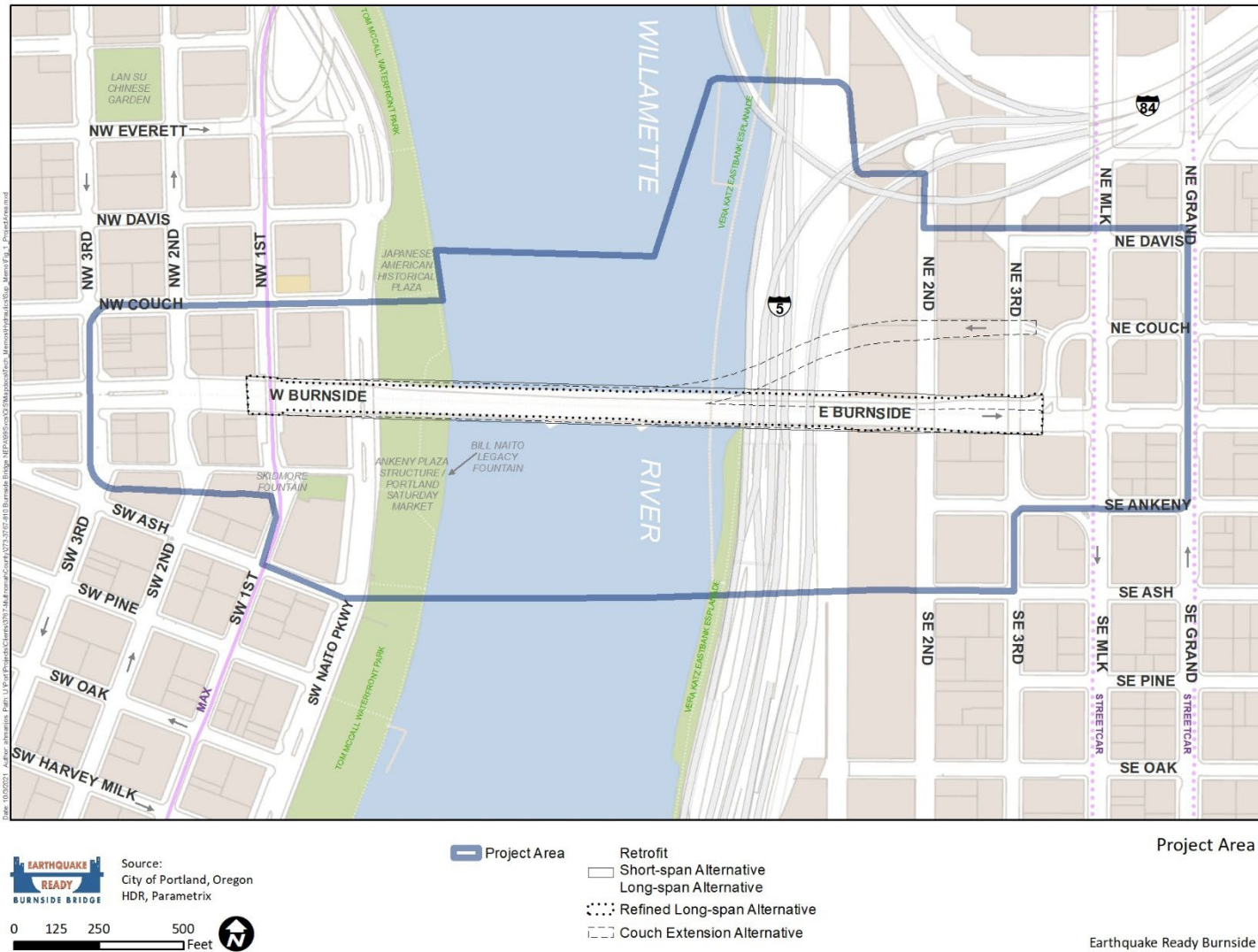

## 2 Project Alternatives

This technical memorandum evaluates potential design refinements to the Draft EIS Preferred Alternative. All of the Project Alternatives evaluated in the Draft EIS are summarized in Chapter 2 of the Draft EIS and described in detail in the *EQRB Description of Alternatives Report* (Multnomah County 2021a). Briefly, the Draft EIS evaluated a No-Build Alternative and four Build Alternatives. One of the Build Alternatives, the Long-span Alternative, was identified as the Preferred Alternative. The potential refinements evaluated in this technical memorandum are collectively referred to as the Refined Long-span Alternative (Four-lane Version) or the Refined Long-span. The Refined Long-span includes Project elements that were studied in the Draft EIS but have been modified as well as new options that were not studied in the Draft EIS. These refinements and new options are intended to provide lower cost and, in some cases, lower impact designs and ideas that could be adopted to reduce the cost of the Draft EIS Preferred Alternative while still achieving seismic resiliency. The potential design refinements, and how they differ from the Draft EIS Long-span Alternative, are described below.

The design refinements that were considered for the hydraulic analysis, and how they differ from the Draft EIS Long-span Alternative are described below:

- Bridge width
  - The total width of the bridge over the river would be approximately 82 to 93 feet (range varies with bridge type and segment); by comparison, the Draft EIS Replacement Alternatives were approximately 110 to 120 feet wide over the river.
  - A narrower bridge would allow narrower in-water piers, due to less weight transferring into the in-water supports.
- Other design refinements included in the hydraulics impacts analysis:
  - West approach – This memo evaluates a refined girder bridge type for the approach over the west channel of the river, Gov. Tom McCall Waterfront Park, and Naito Parkway. Compared to the cable-stayed and tied-arch options evaluated in the Draft EIS, this option would have two sets of columns in Waterfront Park compared to just one with the tied-arch option and five with the existing bridge.
  - East approach – This memo evaluates a potential span length change for the east approach tied-arch option that would minimize the risks and reduce costs associated with placing a pier and foundation in the geologic hazard zone that extends from the river to about E 2nd Avenue. The refined tied-arch option would be about 720 to 820 feet long and approximately 150 feet tall (the Draft EIS Long-span alternative was the same height and 740 feet long). The Refined Alternative would place the eastern pier of the tied-arch span either on the east side of 2nd Avenue (Option 1) or just west of 2nd Avenue (Option 2). Option 1 was evaluated as part of this hydraulic analysis.

- Americans with Disabilities Act (ADA) Access – The Draft EIS evaluated multiple ramp, stair, and elevator options. This SDEIS memo does not include an evaluation of a refined option that would provide enhanced ADA access at both locations providing both elevators and stairs for pedestrian and bicycle access. For the west end, there is also the potential for replacing the existing stairs with improved sidewalk access from the west end of the bridge to 1st Avenue. A more detailed analysis can be found in the associated *EQRB Revised Active Transportation Access Options Memo* (Multnomah County 2022), including an evaluation of the refined structures that would provide direct ADA access between the bridge and the Vera Katz Eastbank Esplanade, as well as between the bridge and W 1st Avenue including the Skidmore Fountain MAX station.
- Construction assumptions included in hydraulics impacts analysis:
  - Construction Duration – The expected duration of project construction is 4.5 to 5.5 years, dependent upon the design option.
  - Construction Access and Staging – The construction access and staging is expected to be the same as that described in the Draft EIS.
  - In-water Work Activity – The in-water work would be similar to that described in the Draft EIS, except that the replacement bridge in-water foundations would consist of a perched footing cap and a group of drilled shafts. Whereas the Draft EIS discusses the use of cofferdams to isolate in-water work, the Refined Long-span Alternative would use a temporary caisson lowered to an elevation about mid-height of the water column to construct footing caps, avoiding additional disturbance of the riverbed that would be needed for a cofferdam. Additionally, the existing Pier 4 would be fully removed, Pier 1 would be partially removed below the mudline, and Piers 2 and 3 would be removed to below the mudline. Existing in-water piles would be removed, subject to the design option advanced.

## 3 Definitions

The following terminology is used when discussing geographic areas in the EIS:

- **Project Area** – The area within which improvements associated with the Project Alternatives would occur and the area needed to construct these improvements. The Project Area includes the area needed to construct all permanent infrastructure, including adjacent parcels where modifications are required for associated work such as utility realignments or upgrades. For the EQRB Project, the Project Area includes approximately a one-block radius around the existing Burnside Bridge and W/E Burnside Street, from NW/SW 3rd Avenue on the west side of the river and NE/SE Grand Avenue on the east side.
- **Area of Potential Impact (API)** – This is the geographic boundary within which physical impacts to the environment could occur with the Project Alternatives. The API is resource-specific and differs depending on the environmental topic being addressed. The API for hydraulics is defined in Section 5.1 of the *EQRB Hydraulic Impact Analysis Technical Report* (Multnomah County 2021c).

- **Project vicinity** – The environs surrounding the Project Area. The project vicinity does not have a distinct geographic boundary but is used in general discussion to denote the larger area, inclusive of the Old Town/Chinatown, Downtown, Kerns, and Buckman neighborhoods.
- **Base flood** – The flood having a 1 percent chance of being equaled or exceeded in any given year. Also referred to as the 100-year flood.
- **Regulatory floodway** – The channel of a river or other watercourse and the adjacent land areas that have been reserved in order to discharge the base flood without cumulatively increasing the water surface elevation more than one foot, as based on computer simulation or other calculations.
- **100-year flood** – A common term used for the base flood.
- **500-year flood** – The flood having a 0.2 percent chance of being equaled or exceeded in any given year.
- **No-rise certification** – A technical analysis for a project in a regulatory floodway demonstrating that the project will not increase the base flood elevation. The no-rise certification must be conducted before a permit can be issued, signed by a registered professional engineer, and supported by technical data based on the standard step-backwater computer model used to develop the regulatory floodway boundaries.
- **Scour** – Scour is the erosion of streambed material caused by the flow of water around structures and through the channel. Total scour is the sum of long-term degradation, contraction scour, and local scour. If the streambed material is contaminated, scour can mobilize pollutants into the water. The threshold for scour depends on several factors including bed material grain size and water velocity. The risk of scour is usually increased during the construction phase of in-water work.
- **Long-term degradation** – Long-term changes to streambed elevation due to natural or human-made causes that can affect the reach of river on which a bridge is located. Degradation involves the lowering or scouring of the streambed over relatively long reaches, which is generally due to the lack of sediment coming into the river from upstream. (Aggradation happens when mobilized sediments from an upstream area are deposited near a structure. Aggradation is more commonly associated with low velocity flows and is not considered as a component of total scour.)
- **Contraction scour** – Scour that is caused by a narrowing of the channel that increases velocity of the water and shear stress on the riverbed, generally resulting in scour of material from the bed across all or most of the channel.
- **Local scour** – Scour that is caused by the water's momentum being interrupted by a structure in its path and pressure differences that cause the flow to be pushed downward and scour holes near the structure. Local scour generally removes material from around the piers, abutments, spurs, and embankments of a channel. Local scour along the banks impacts overall channel hydraulics and scour along bridge piers can impact bridge stability.

## 4 Relevant Regulations

There are no changes to the regulations listed in the *EQRB Hydraulic Impact Analysis Technical Report* (Multnomah County 2021c).

## 5 Analysis Methodology

The evaluation methods described in Section 5.2.3 of the *EQRB Hydraulic Impact Analysis Technical Report* have been updated to include the following:

- Following a review of the Draft EIS and the selection of a Preferred Alternative, the bridge design now includes potential refinements, and detailed hydraulic modeling of the channel would be conducted to support the Final EIS. The results will be documented in a hydraulic modeling report.

The long-term impact assessment methods described in Section 6.1 of the *EQRB Hydraulic Impact Analysis Technical Report* have been updated to include the following:

- Following the selection of a Preferred Alternative, potential refinements have been developed for the Draft EIS Replacement Long-span Alternative bridge design, which have been updated in this supplemental memo and in Appendix A. Detailed hydraulic modeling of the channel would be conducted to support the Final EIS, and the modeling results would be documented in a hydraulic modeling report.

There are no changes to the following impact assessment methods detailed in the *EQRB Hydraulic Impact Analysis Technical Report*:

- The short-term impact assessment methods, which can be found in Section 6.2.
- The indirect impact assessment methods, which can be found in Section 6.3.
- The cumulative impact assessment methods, which can be found in Section 6.4.

## 6 Affected Environment

There are no changes to the following sections regarding the affected environment:

- The defined API, which can be found in Section 5.1. in the *EQRB Hydraulic Impact Analysis Technical Report* (Multnomah County 2021c).
- The published sources and databases, or the field visits and surveys, which can be found in Sections 5.2.1 and 5.2.2 respectively in the technical report.
- The defined existing conditions, which can be found in Sections 5.3.1 through 5.3.7. in the technical report.

## 7 Impacts from the Design Modifications and Comparison to Draft EIS Alternatives

### 7.1 Pre-Earthquake Impacts

This section describes the effects of the alternatives prior to a Cascadia Subduction Zone earthquake, similar to Section 7.1 in the *EQRB Hydraulic Impact Analysis Technical Report* (Multnomah County 2021c).

#### 7.1.1 No-Build Alternative

There are no changes to the No-Build Alternative described in Section 7.1.1 of the *EQRB Hydraulic Impact Analysis Technical Report*.

#### 7.1.2 Impacts Common to all Build Alternatives

There are no changes to the Build Alternatives described in Sections 7.1.2 through 7.1.6 of the *EQRB Hydraulic Impact Analysis Technical Report* except for the changes discussed below, which would apply to all the Build Alternatives discussed in the technical report. The environmental consequences identified in Section 7.1.2 of the technical report and the Draft EIS evaluated multiple for ramp, stair, and elevator options for ADA access between the bridge and the Eastbank Esplanade, as well as between the bridge and W 1st Avenue including the Skidmore Fountain MAX station. These ADA access options have been replaced by a refined option. The SDEIS includes a refined option that would provide enhanced ADA access at both locations providing both elevators and stairs for pedestrian and bicycle access. Similar to the ADA access options described in the Draft EIS, impacts resulting from the placement of structural support shafts associated with the refined ADA access option include the potential to increase base flood elevations, increase contraction scour by constricting flows and narrowing the channel area, as well as increase local or pier scour when the capacity of the flow to erode and transport sediments is larger than the capacity to replace the sediments. The sum of these scours, or the total scour, has the potential to mobilize contaminated sediments when compared to the No-Build Alternative.

As discussed in the *EQRB Hydraulic Impact Analysis Technical Report*, the ramp and stair options would place the highest amount of fill in the floodplain, and the highest increase in scour could be expected compared to the refined option and the No-Build Alternative; this option would place the greatest number of shafts below the ordinary high water level and within the regulatory floodway of the channel. The refined ADA access option, which includes stairs and elevator configuration, would place more fill in the floodplain compared to the No-Build Alternative but less than the ramp and stair options, placing fewer shafts below the ordinary high water level and within the regulatory floodway of the channel than the ramp and stair options would. The refined option would have less potential to disturb sediments than the ramp and stair options, but the elevator support structures would be located in the vicinity of an area of previously identified riverbed scouring. A full qualitative hydraulic analysis of impacts associated with the refined ADA access options is available in the *EQRB Revised Active Transportation Access Options Memo* (Multnomah County 2022). Hydraulic impacts resulting from the



refined ADA access approach would be in addition to the impacts of the bridge alternatives identified by the access options memo.

Similar to the summary table in Section 7.1.2 of the *EQRB Hydraulic Impact Analysis Technical Report*, Table 1 below presents a comparison of the magnitude of floodway encroachment (based on the Willamette River floodway cross-sectional area calculated by the Federal Emergency Management Agency) that includes the Refined Long-span Alternative. The updated range of change in potential scour length for the alternatives is presented in Table 2. The updated range of conceptual floodplain impacts outside of the floodway is presented in Table 3.

**Table 1. Estimated Floodway Encroachment**

Alternative	Total Lateral Surface Area (sq ft) <sup>a</sup>	Change Compared to Existing (sq ft) <sup>b</sup>	Floodway Cross-Sectional Area (sq ft)	Percent of Floodway Occupied by Permanent Structures	Difference Compared to Existing <sup>c</sup> (percent)
<b>No Change</b>					
No-Build (existing)	11,213	-	65,683	17	-
<b>Lower Impact</b>					
Refined Long-Span Alternative <sup>d</sup> -vertical lift	7,426	-3,787	65,683	11	-6
Refined Long-Span Alternative <sup>d</sup> -bascule lift	9,481	-1,732	65,683	14	-3
Draft EIS Long-Span Alternative <sup>e</sup> – vertical lift	10,610	-602	65,683	16	-1
<b>Higher Impact</b>					
Draft EIS Long-Span Alternative <sup>d</sup> – bascule lift	14,664	3,451	65,683	22	5

Source: Existing base flood elevation of 32 feet (FEMA 2010).

<sup>a</sup> Total lateral surface area: In contact with the flow of the water at base flood elevation.

<sup>b</sup> Total change in lateral surface area: difference between an Alternative’s lateral surface area and existing lateral surface area. Negative values indicate a decrease.

<sup>c</sup> In the *EQRB Hydraulic Impact Analysis Technical Report* and Draft EIS this was called “Increase Compared to Existing,” the title was updated to “Difference compared to existing” because the impacts now mainly represent a decrease in the percent of the floodway occupied. The difference was calculated by finding the total change in lateral surface area and applying it to the floodway cross sectional area, represented as a percent for comparative purposes.

<sup>d</sup> The Refined Long-span Alternatives were analyzed for both the tied-arch and cable-stayed configurations, and the full table for results are presented in Appendix A. Both configurations would have the same impacts with respect to floodway encroachment.

<sup>e</sup> The Draft EIS Long-span Alternatives were analyzed using the tied-arch configuration. Cable-stayed configurations would have similar impacts.

sq ft = square feet

**Table 2. Estimated Percent Change in Scour Length<sup>a</sup>**

Alternative	Pier 1 <sup>b</sup>	Pier 2	Pier 3	Pier 4
<b>No Change</b>				
No-Build (existing)	-	-	-	-
<b>Lower Increase</b>				
Draft EIS Long-Span Alternative <sup>c</sup> – vertical lift	-100	15	15	-100
Draft EIS Long-Span Alternative <sup>c</sup> – bascule lift	-100	43	43	-100
<b>Medium Increase</b>				
Refined Long-Span Alternative <sup>d</sup> – bascule lift	-100	107	107	-100
Refined Long-Span Alternative <sup>d</sup> – vertical lift	-100	107	107	-100

Source: Lengths sourced from respective design plan sets (Multnomah County) and measured in Bluebeam.

<sup>a</sup> Percent change calculated based on percent increase in footing length compared to existing condition. Magnitude categories (lower, medium, etc.) are based on the original ranges used in the Draft EIS.

<sup>b</sup> The scour analysis is based on footprint size change to each pier. It is assumed for all of the Replacement Alternatives considered in the SDEIS that Pier 1 would be removed to below the mudline.

<sup>c</sup> The Draft EIS Long-span Alternatives were analyzed using the tied-arch configuration. The cable-stayed configurations would be anticipated to have similar in-channel impacts.

<sup>d</sup> The Refined Long-span Alternatives were analyzed for both the tied-arch and cable-stayed configurations, and the full table for results are presented in Appendix A. Both configurations would have the same impacts with respect to floodway encroachment.

**Table 3. API Floodplain Encroachment (Outside of the Floodway)**

Alternative	West Approach (ft)	East Approach (ft)	Design Total (ft)
<b>No Change</b>			
No-Build (existing)	180	61	241
<b>Lower Impact</b>			
Draft EIS Long-Span Alternative – tied-arch	106	12	118
Refined Long-Span Alternative – tied-arch	120	12	132
Draft EIS Long-Span Alternative – cable-stayed	111	47	158
Refined Long-Span Alternative – cable-stayed	106	40	146

ft = feet

## Indirect

There are no changes to the indirect impacts described in Section 7.1.2 of the *EQRB Hydraulic Impact Analysis Technical Report* (Multnomah County 2021c).

### 7.1.3 Draft EIS Replacement Alternative with Long-Span Approach

There are no changes to the expected impacts described in Section 7.1.5 of the *EQRB Hydraulic Impact Analysis Technical Report*. The Draft EIS Long-span Alternative would place fewer bent and pier structures in the main river channel than the No-Build Alternative, eliminating Piers 1 and 4 of the existing bridge to below the mudline. Removal of the piers was included in the Draft EIS design; however, the update of the design to include removal of the remnants of Pier 1 to below the mudline would further reduce the expected floodway encroachment. The Draft EIS Long-span Alternative values for total lateral surface area in Table 1 of this analysis are lower compared to the values in Table 2 of the *EQRB Hydraulic Impact Analysis Technical Report*. This can be attributed to the removal of the remnants of existing structure Pier 1 to below the mudline; the Draft EIS Long-Span design was not changed.

### 7.1.4 Refined Alternative with Long-Span Approach

The Refined Long-span Alternative includes a narrower bridge with narrower in-water piers that would result in less floodway encroachment. Compared to the No-Build and Draft EIS Long-span Alternatives, the Refined Long-span Alternatives would have the lowest potential for increasing the base flood elevation. The vertical lift option would have the lowest potential among the refined build alternatives. Due to updates in the footing design configuration that would span the existing footings, the Refined Long-span Alternatives would have longer footings in the direction of the flow. These longer footings could increase the potential for pier scour as compared to the Draft EIS Long-Span and No-Build Alternatives, but the removal of the remnants of Pier 1 to below the mudline would reduce the potential for local pier scour in the area.<sup>1</sup>

The Refined Long-span Alternative would place the eastern pier of the tied-arch span either on the east side of 2nd Avenue (Option 1) or just west of 2nd Avenue (Option 2). Both Options 1 and 2 would place the eastern pier outside of the floodway. The plan sheets evaluated for this analysis depict Option 1; however, both Options 1 and 2 would be expected to have the same hydraulic impacts for the purpose of this analysis. All of the Build Alternatives would place fewer shafts in the 500-year floodplain outside the mapped floodway than the No-Build Alternative, and the Draft EIS Long-span and Refined Long-span Alternatives would be expected to have a similar magnitude of effects on floodplain encroachment.

Compared to the other Build Alternatives, the potential refinements to the Long-span Alternative would have the following impacts:

---

<sup>1</sup> Please note that partial removal of Pier 1 was introduced as a design element subsequent to completion of the hydraulic analysis discussed here. Hydraulic analysis for partial Pier 1 removal will be updated for the final design.

*Refined Long-Span Alternative with Bascule Lift*

- Floodway encroachment (Table 1): Lower
- Scour increase (Table 2): Higher

*Refined Long-Span Alternative with Vertical Lift*

- Floodway encroachment (Table 1): Lowest
- Scour increase (Table 2): Higher

*Refined Long-Span Alternative with Cable-Stayed Support*

- Floodplain encroachment outside of floodway (Table 3): Lower

*Refined Long-Span Alternative with Tied-Arch Support*

- Floodplain encroachment outside of floodway (Table 3): Lowest

## 7.2 Post-Earthquake Impacts

There are no changes to the post-earthquake impacts described for the No-Build Alternative in Section 7.2.1 of the *EQRB Hydraulic Impact Analysis Technical Report* (Multnomah County 2021c). The Refined Long-span, similar to the Draft EIS Long-span Alternative, would be anticipated to have the same low risk level for structural failure and associated deposition of bridge material into the river channel, resulting in the fewest hydraulic impacts, as described in Section 7.2.3 of the *EQRB Hydraulic Impact Analysis Technical Report*.

## 7.3 Construction Impacts

### 7.3.1 Impacts Common to All Alternatives

There are no changes to the construction impacts for any of the alternatives described in Section 7.3 in the *EQRB Hydraulic Impact Analysis Technical Report*. The expected duration of the project construction has been updated to 4.5 to 5.5 years, dependent on the design option.

As stated in the *EQRB Hydraulic Impact Analysis Technical Report* and updated to include the refined option, temporary construction of the ADA access options would involve the excavation and removal of contaminated soils and rip rap in the main channel of the river, along the embankment, and in the riparian areas. In-water work to construct the permanent structures could include the use of cofferdams and a seal course, pile driving, and the placement of the support shafts. These activities would temporarily increase the potential for contraction scour and mobilization of contaminated sediments in the near-shore area during construction, in an area where previous scour effects have been noted.

The in-water work for the Refined Long-span Alternative would be similar to the Draft EIS Long-span Alternative as it is described in the *EQRB Hydraulic Impact Analysis Technical Report*, except the replacement bridge in-water foundations would be raised, thereby limiting the need for cofferdams to an elevation about mid-height of the river.

Additionally, the existing piers would be fully removed, and the existing in-water piles would be removed, subject to the design option advanced. In-water work to remove and replace the piers would include the use of cofferdams and a seal course, pile driving, and the construction or placement of the support shafts. These activities would temporarily increase the potential for contraction scour and mobilization of contaminated sediments in the channel, and the impacts resulting from the cofferdam placement are anticipated to be fewer with the potential design refinements compared to those discussed in the Draft EIS.

### Refined Replacement Alternative with Long-Span Approach

The principal difference with the potential design refinements of the Refined Long-span Alternative with cable-stayed design option is the elimination of two intermediate bents as compared with the Draft EIS Long-span Alternative with the cable-stayed design option. The Refined Long-span with either design option (tied-arch or cable-stayed) would place one less bent along the west approach and one less bent along the east approach within the floodplain outside the floodway than the Draft EIS Long-span with tied-arch design option (previously the lowest anticipated impact), which would have fewer associated impacts during construction.

## 7.3.2 With Temporary Work Bridge

### Impacts Common to All Alternatives

The estimated amount of floodway encroachment associated with the temporary work bridge has been updated to reflect the changes in floodway encroachment for the Draft EIS Long-Span and Refined Long-span Alternatives. These values are presented in Table 4, and the supporting calculations are detailed in Appendix A with a complete list of assumptions.

**Table 4. Estimated Temporary Floodway Encroachment**

Alternative	Floodway Cross-Sectional Area (sq ft)	Permanent Bridge		Work Bridge		Total Percent of Floodway Occupied
		Total Lateral Surface Area (sq ft) <sup>a</sup>	Percent of Floodway Occupied	Total Lateral Surface Area (sq ft) <sup>a</sup>	Percent of Floodway Occupied	
<b>No Change</b>						
No-Build (existing)	65,683	11,213	17	-	-	17
<b>Lowest Impact</b>						
Refined Long-Span Alternative <sup>d</sup> – vertical lift (lowest impact)	65,683	7,426	11	3,920	6	17
Refined Long-Span Alternative <sup>d</sup> – bascule lift	65,683	9,480	14	3,640	6	20

Alternative	Floodway Cross-Sectional Area (sq ft)	Permanent Bridge		Work Bridge		Total Percent of Floodway Occupied
		Total Lateral Surface Area (sq ft) <sup>a</sup>	Percent of Floodway Occupied	Total Lateral Surface Area (sq ft) <sup>a</sup>	Percent of Floodway Occupied	
Draft EIS Long-Span Alternative <sup>c</sup> – vertical lift	65,683	10,610	16	3,640	6	22
<b>Highest Impact</b>						
Draft EIS Long-Span Alternative <sup>c</sup> – bascule lift (highest impact)	65,683	14,664	22	3,640	6	28

Source: Existing Base Flood Elevation of 32 feet (FEMA 2010).

<sup>a</sup> Total Lateral Surface Area: In contact with the flow of the water at base flood elevation

<sup>b</sup> Total Percent of Floodway Occupied: sum of permanent and temporary lateral surface area floodway encroachments of floodway cross-sectional area.

<sup>c</sup> The Draft EIS Long-span Alternatives were analyzed using the tied-arch configuration. Cable-stayed support configurations would have similar impacts.

<sup>d</sup> The Refined Long-span Alternatives were analyzed for both the tied-arch and cable-stayed configurations, and the full table for results are presented in Appendix A. Both configurations would have the same impacts with respect to floodway encroachment.

As described in the *EQRB Hydraulic Impact Analysis Technical Report* (Multnomah County 2021c), the base flood elevation could temporarily increase during construction when cofferdams are placed to surround existing and potential footprints for permanent piers and for construction of the temporary work bridge. These actions could result in impacts to the water surface elevation of the river which would likely rise in response during the stages of placement. The temporary water surface elevation impacts would then likely decrease when temporary construction structures are removed. Hydraulic modeling would be conducted at a later phase to calculate base flood elevation impacts during construction for the potential refinements to the Draft EIS Long-span Alternative and any resultant changes to the construction approach.

#### Off-Site Staging Areas

There are no changes to the construction access and staging for any of the alternatives described in the Section 7.3.3 of the *EQRB Hydraulic Impact Analysis Technical Report* (Multnomah County 2021c).

## 7.4 Cumulative Effects

There are no changes to the cumulative impacts for any of the alternatives described in Sections 7.4.1 (No-Build) and 7.4.2 (Build Alternatives) of the *EQRB Hydraulic Impact Analysis Technical Report*.

## 7.5 Compliance with Laws, Regulations, and Standards

The same level of compliance would be followed for the potential design refinements as described in Section 7.5 of the *EQRB Hydraulic Impact Analysis Technical Report*. Following the review of the Draft EIS and the selection of a Preferred Alternative, the bridge design has been advanced and potential refinements to the design have been defined. Detailed hydraulic modeling of the channel would be conducted to determine the precise base flood elevation impact, and results would be documented in a hydraulic modeling report.

For many of these elements, complying with the National Environmental Policy Act would satisfy the process requirements; however, additional details would be presented in the Final EIS including modeling analysis of the floodplain and floodway impacts. The detailed analysis would be initiated after the potential refinements have been selected for the Preferred Alternative, and the analysis would include additional modeling of the temporary impacts and chosen construction scenario.

## 7.6 Conclusion

As stated in the *EQRB Hydraulic Impact Analysis Technical Report* (Multnomah County 2021c), all the Build Alternatives' pier designs are anticipated to create some degree of hydraulic encroachment and result in an increase in the base flood elevation, as well as an increased scour potential, which could result in the mobilization and transport of contaminated sediments present in the riverbed. The Refined Long-span Alternatives would have less potential for increasing the base flood elevation compared to the Draft EIS Long-span Alternatives, and the vertical lift option would have the lowest potential among the refined lift configurations. The Refined Long-span Alternatives would have longer footings in the direction of the flow which could increase the potential for pier scour as compared to the Draft EIS Long-Span and No-Build Alternatives. The Draft EIS Long-span and Refined Long-span Alternatives would be expected to have a similar magnitude of effects on floodplain encroachment resulting from the placement of shafts in the 500-year floodplain outside the mapped floodway.

Impacts resulting from the refined ADA access option compared to the No-Build Alternative include an increase in base flood elevations and the potential for increased scour in an area with previously identified riverbed scouring, which could mobilize contaminated sediments. The refined ADA access option would place more fill in the floodplain compared to the No-Build Alternative but less than the superseded stairs and elevator options—including fewer shafts below the ordinary high water level and within the regulatory floodway of the channel than the ramp and stairs options.

Detailed modeling analysis would be initiated after the potential refinements to the Draft EIS Preferred Alternative have been selected to identify design changes that would avoid or minimize these impacts. If impacts could not be avoided through design, the Project would coordinate with the City to comply with floodplain impact regulations and scour prevention and monitoring measures and acquire federal approval of the impact.

## 8 Potential Mitigation

There are no changes to the potential opportunities to mitigate or minimize the impacts associated with the Project that are described in Sections 8.1 (All Build Alternatives) or 8.2 (Temporary Detour Bridge Option) of the *EQRB Hydraulic Impact Analysis Technical Report* (Multnomah County 2021c).

## 9 Agency Coordination

No new coordination associated with the information contained in or for the preparation of this memo was necessary. See Section 9 of the *EQRB Hydraulic Impact Analysis Technical Report* for the original list of agencies and organizations.

## 10 Preparers

Name	Professional Affiliation	Education	Years of Experience
Julie Brandt, PE	Parametrix	BS, Civil Engineering	23
Arianna Frender	Parametrix	MS, Civil and Environmental Engineering	2



# 11 References

## Multnomah County.

- 2021a. EQRB Description of Alternatives. [Project Library | Multnomah County \(multco.us\)](#)
- 2021b. EQRB Draft Environmental Impact Statement. [Project Library | Multnomah County \(multco.us\)](#).
- 2021c. EQRB Hydraulic Impact Analysis Technical Report. [Project Library | Multnomah County \(multco.us\)](#).
- 2022. EQRB Revised Active Transportation Access Options Memo. [Project Library | Multnomah County \(multco.us\)](#).

This page intentionally left blank.

# Appendix A. Preliminary Hydraulic Impact Estimates

This page intentionally left blank.

Lateral Surface Area (sq ft)	Pier 1		Pier 2				Pier 3				Pier 4	
	Footing	Column	Footing/S haft	Pier Cap	Column	Pier Protection	Footing/ Shaft	Pier Cap	Column	Pier Protection	Footing	Column
Existing	0	717	1,492	0	3,422	0	1,487	0	3,491	0	171	434
DEIS Long Span-Cable/Bascule	0	0	3,710	0	3,282	223	3,710	0	3,309	219	0	0
DEIS Long Span-Arch/Bascule	0	0	3,710	0	3,406	244	3,710	0	3,369	225	0	0
DEIS Long Span-Cable/Lift	0	0	2,800	0	2,258	203	2,800	0	2,319	231	0	0
DEIS Long Span-Arch/Lift	0	0	2,800	0	2,258	203	2,800	0	2,319	231	0	0
Refined Long Span-Cable/Bascule	0	0	858	1,728	1,670	450	889	1,728	1,709	450	0	0
Refined Long Span-Arch/Bascule	0	0	858	1,728	1,670	450	889	1,728	1,709	450	0	0
Refined Long Span-Cable/Lift	0	0	676	1,728	813	453	749	1,728	826	453	0	0
Refined Long Span-Arch/Lift	0	0	676	1,728	813	453	749	1,728	826	453	0	0

Assumptions:

- \*Existing structure pier 1 conservative estimate assumes entire column exposed and footing buried
- \*All replacement alternatives assume Pier 1 structure to be removed below mudline
- \*Pier 2 for all DEIS Long Span Alternatives assume bathymetry with 15 feet of footing is buried into the ground.
- \*Pier 2 for all Refined Long Span Alternatives measured using the bathymetry indicated on the plan set.
- \*Pier 3 for all DEIS Long Span Alternatives assume bathymetry with 15 feet of footing is buried into the ground.
- \*Pier 3 for all Refined Long Span Alternatives measured using the bathymetry indicated on the plan set.
- \*All replacement alternatives assume Pier 4 structure to be removed below mudline
- \*DEIS Long Span Lift Combinations were assumed to have the same sized elements as the Short approach span/Lift Combination, and the same configuration/ # of piers in the main channel as the Long Span Bascule Combination. Short Span Sheet included for reference.

Floodway Calculations

Cross Section	Distance (miles)	Width (ft)	Cross sectional Area (sq ft)
P	12.3	1,144	70,636
Q	12.6	849	60,729
Burnside Bridge	12.4	997	65,683

Assumptions:

- \* distance is miles above mouth
- \* computed without consideration of influence from the Columbia River
- \* Burnside=average area of FEMA designated cross sections P and Q

### Two Dimensional Floodway Encroachment

Alternative	Pier 1	Pier 2	Pier 3	Pier 4	Total Lateral Surface Area	Total Change in LSA (sq. ft.)	Floodway Cross sectional area (sq ft)	Percent of floodway occupied by permanent structures %	Difference Compared to Existing %
Existing	717	4,914	4,979	604	11,213	0	65,683	17	0
DEIS Long Span-Cable/Bascule	0	7,215	7,238	0	14,453	3,240	65,683	22	5
DEIS Long Span-Arch/Bascule	0	7,360	7,304	0	14,664	3,451	65,683	22	5
DEIS Long Span-Cable/Lift	0	5,261	5,350	0	10,610	-602	65,683	16	-1
DEIS Long Span-Arch/Lift	0	5,261	5,350	0	10,610	-602	65,683	16	-1
Refined Long Span-Cable/Bascule	0	4,705	4,775	0	9,480	-1,733	65,683	14	-3
Refined Long Span-Arch/Bascule	0	4,705	4,776	0	9,481	-1,732	65,683	14	-3
Refined Long Span-Cable/Lift	0	3,671	3,756	0	7,426	-3,787	65,683	11	-6
Refined Long Span-Arch/Lift	0	3,671	3,756	0	7,426	-3,787	65,683	11	-6

Assumptions:  
 \* Assume 32 foot BFE from FEMA  
 \* Assume width of Floodway from FEMA, averaging the channel areas at cross sections P and Q.  
 \* Total Change in LSA = Proposed Lateral Surface Area-Existing Lateral Surface Area  
 \* Percent of floodway occupied= (Total LSA /FW CSA)\*100

### Footing Length

Alternative	Plan View (ft)	Pier 1 Length Footing	Pier 2 Length Footing	Pier 3 Length Footing	Pier 4 Length Footing
Existing		71	122	122	68
DEIS Long Span-Cable/Bascule		0	175	175	0
DEIS Long Span-Arch/Bascule		0	175	175	0
DEIS Long Span-Cable/Lift		0	140	140	0
DEIS Long Span-Arch/Lift		0	140	140	0
Refined Long Span-Cable/Bascule		0	252	252	0
Refined Long Span-Arch/Bascule		0	252	252	0
Refined Long Span-Cable/Lift		0	252	252	0
Refined Long Span-Arch/Lift		0	252	252	0

Assumptions:  
 \*Existing Structure lengths sourced form record drawings (1924-02-21\_Burnside As-Bulits)  
 \*Long Span Alternatives sourced from the Replacement Alternative with Long Span Approach design sheets updated in July 2021.

### Scour Impacts

Alternative	Pier 1 Change (ft)	Pier 2 Change (ft)	Pier 3 Change (ft)	Pier 4 Change (ft)	Pier 1 % Change	Pier 2 % Change	Pier 3 % Change	Pier 4 % Change
Existing	0	0	0	0	0	0	0	0
DEIS Long Span-Cable/Bascule	-71	53	53	-68	-100	43	43	-100
DEIS Long Span-Arch/Bascule	-71	53	53	-68	-100	43	43	-100
DEIS Long Span-Cable/Lift	-71	18	18	-68	-100	15	15	-100
DEIS Long Span-Arch/Lift	-71	18	18	-68	-100	15	15	-100
Refined Long Span-Cable/Bascule	-71	130	130	-68	-100	107	107	-100
Refined Long Span-Arch/Bascule	-71	130	130	-68	-100	107	107	-100
Refined Long Span-Cable/Lift	-71	130	130	-68	-100	107	107	-100
Refined Long Span-Arch/Lift	-71	130	130	-68	-100	107	107	-100

Assumptions:  
 Change=Proposed footing length - Existing footing length  
 %Change=(Increase/Existing Footing)\*100





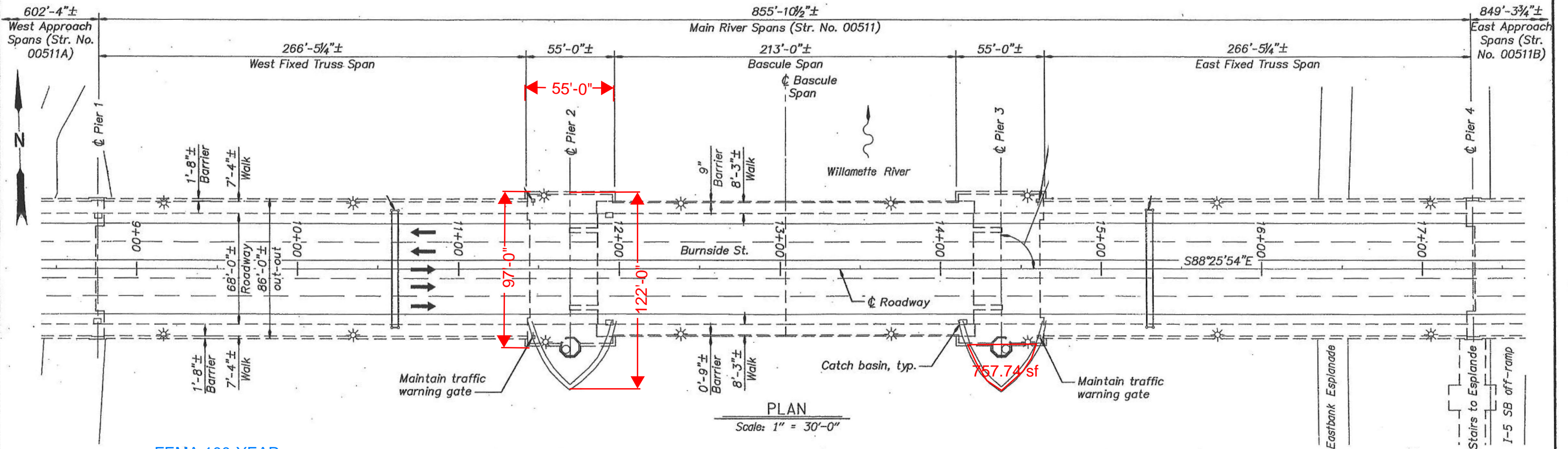

PLAN

Scale: 1" = 30'-0"

FEMA 100-YEAR FLOODPLAIN ELEVATION

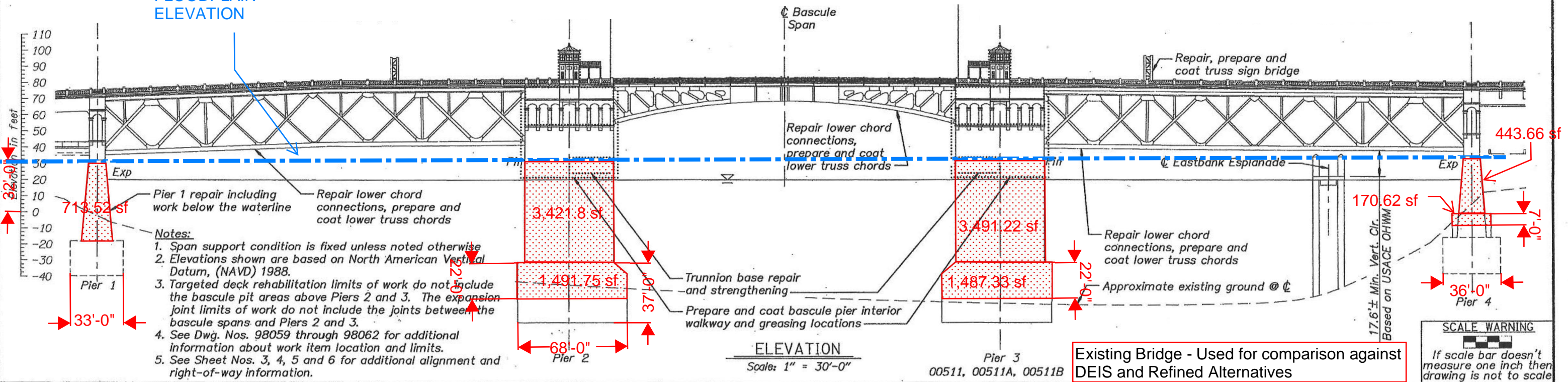

ELEVATION

Scale: 1" = 30'-0"

Notes:

- Span support condition is fixed unless noted otherwise
- Elevations shown are based on North American Vertical Datum, (NAVD) 1988.
- Targeted deck rehabilitation limits of work do not include the bascule pit areas above Piers 2 and 3. The expansion joint limits of work do not include the joints between the bascule spans and Piers 2 and 3.
- See Dwg. Nos. 98059 through 98062 for additional information about work item location and limits.
- See Sheet Nos. 3, 4, 5 and 6 for additional alignment and right-of-way information.

Existing Bridge - Used for comparison against DEIS and Refined Alternatives

SCALE WARNING  
If scale bar doesn't measure one inch then drawing is not to scale

DATE	REVISION	BY

ACCOMPANIED BY DWGS. See Sheet 1 for this structure.

DRAFTER: Dustin Altenburg  
 DESIGNER: Douglas Lampkin  
 CHECKER: Matthew Harlan  
 REVIEWER: Terrence Stones

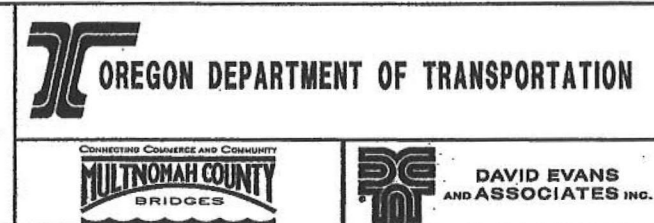
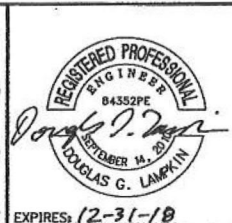

STRUCTURE NO. See above  
 DATE January - 2017  
 CALC. BOOK 6846-6848

BURNSIDE ST: WILLAMETTE RIVER BR  
 PAINT & REHAB PROJECT  
 BURNSIDE STREET  
 MULTNOMAH COUNTY  
 PLAN AND ELEVATION - 2

SHEET 2 OF 60  
 DRAWING NO. 98056

Earthquake Ready Burnside Bridge  
 Replacement Movable Bridge (Bascule) With Long-Span Cable Approach on Existing Alignment  
 MULTNOMAH COUNTY

MULTNOMAH COUNTY  
 DEPARTMENT OF COMMUNITY SERVICES  
 TRANSPORTATION DIVISION  
 1620 S.E. 190th AVE. PORTLAND, ORE. 97233-5989

IAN B. CANNON P.E. COUNTY ENGINEER

DESIGNED BY:	
DRAFTED BY:	
CHECKED BY:	
NO. DATE:	
Sheet No.	BR03

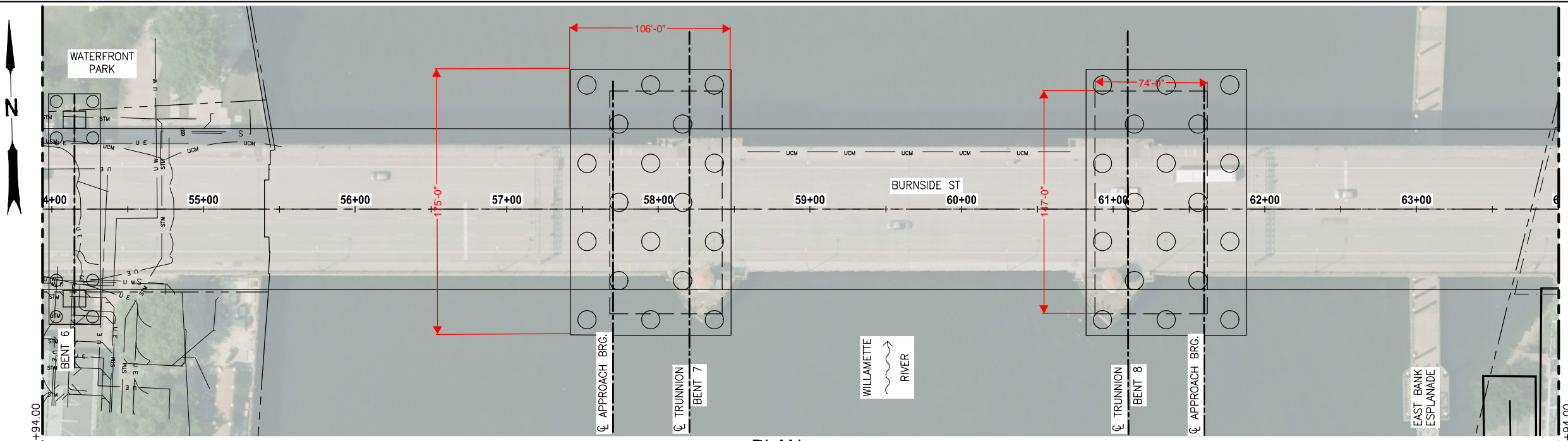

**PLAN**  
 SCALE: 1"=40'

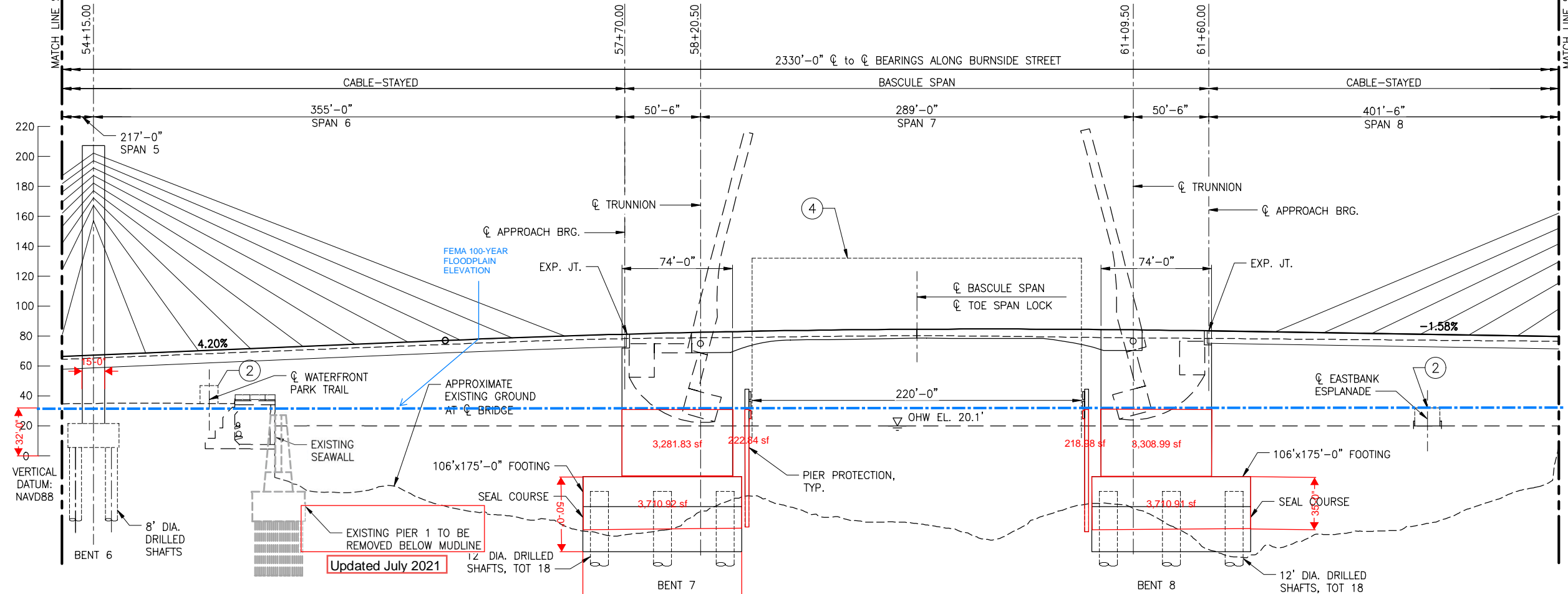

**ELEVATION**  
 SCALE: 1"=40'

**CLEARANCE ENVELOPE LEGEND**

①	LRT	15'-6"	⑤	HIGHWAY	17'-4"
②	PEDESTRIAN	12'-0"	⑥	UPRR	23'-6"
③	CITY STREET	18'-0"	⑦	CITY STREET	13'-8"
④	NAVIGATION	220'-0" W x UNLIMITED H			

**CONCEPTUAL PLANS**  
 JANUARY 2020

Updated July 2021

Earthquake Ready Burnside Bridge  
 Replacement Alternative with Long-span  
 Approach (Bascule)  
 MULTNOMAH COUNTY

MULTNOMAH COUNTY  
 DEPARTMENT OF COMMUNITY SERVICES  
 TRANSPORTATION DIVISION  
 1620 S.E. 190th AVE. PORTLAND, ORE. 97233-9999

IAN B. CANNON P.E. COUNTY ENGINEER

DESIGNED BY:	
DRAFTED BY:	
CHECKED BY:	
NO. DATE:	
SHEET NO.	BR11

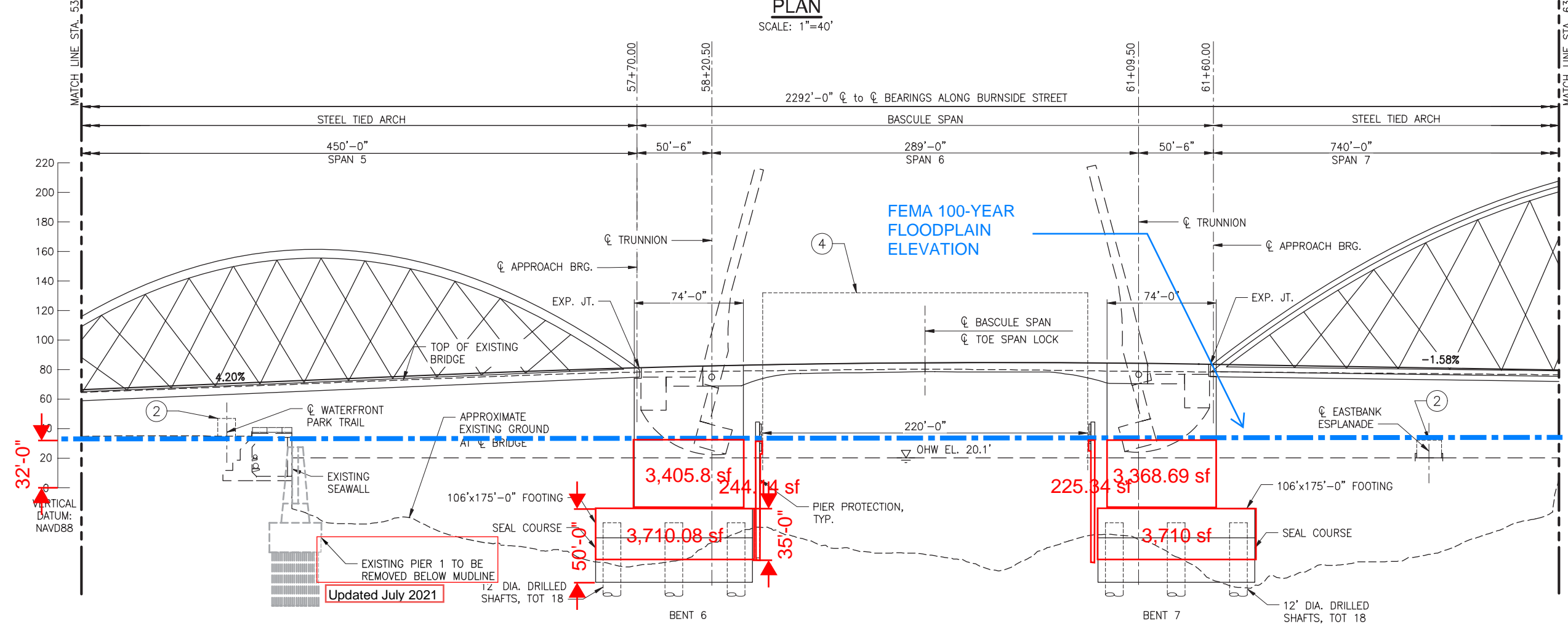
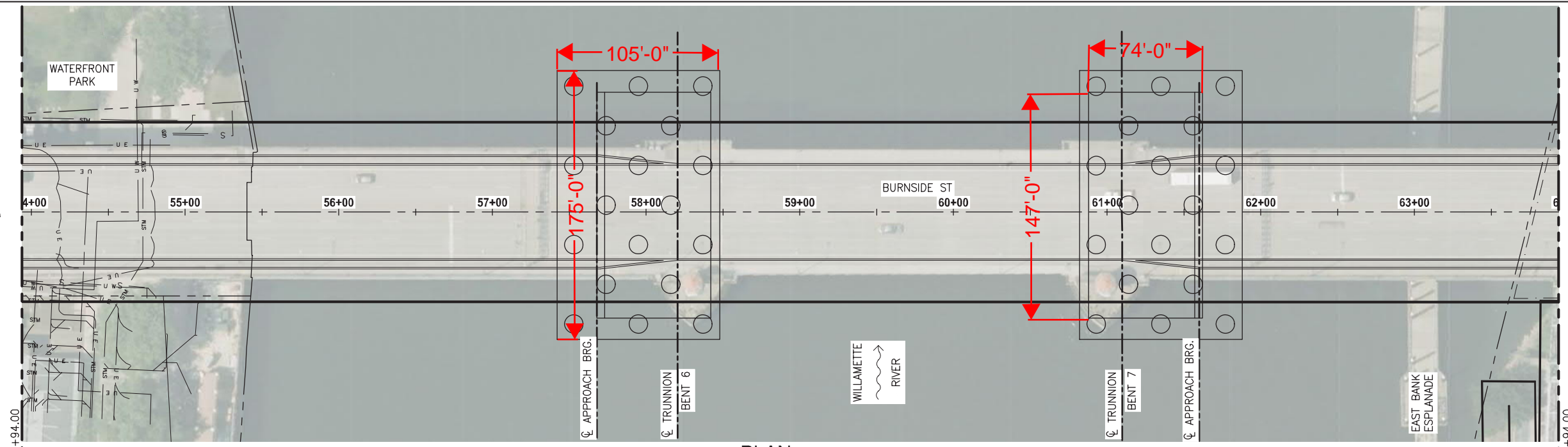

**CLEARANCE ENVELOPE LEGEND**

①	LRT	15'-6"	⑤	HIGHWAY	17'-4"
②	PEDESTRIAN	12'-0"	⑥	UPRR	23'-6"
③	CITY STREET	18'-0"	⑦	CITY STREET	13'-8"
④	NAVIGATION	220'-0" W x UNLIMITED H			

CONCEPTUAL PLANS  
 JUNE 2020

Updated July 2021

DEIS Analysis Assumes Long Span Alternatives with vertical lift Option have same in-water footprint of Short Span Alternatives with Vertical Lift Option. This sheet has been included for Vertical Lift in-water elements.

Earthquake Ready Burnside Bridge  
Replacement Alternative with  
Short-span Approach (Lift)  
MULTNOMAH COUNTY  
PROJECT NO.:

MULTNOMAH COUNTY  
DEPARTMENT OF COMMUNITY SERVICES  
TRANSPORTATION DIVISION  
1620 S.E. 190th AVE. PORTLAND, ORE. 97233-9999  
COUNTY ENGINEER  
IAN B. CANNON P.E.



DESIGNED BY:  
DRAFTED BY:  
CHECKED BY:

REVISIONS

NO.	DATE:	DESCRIPTION:

Sheet No. **BR07**

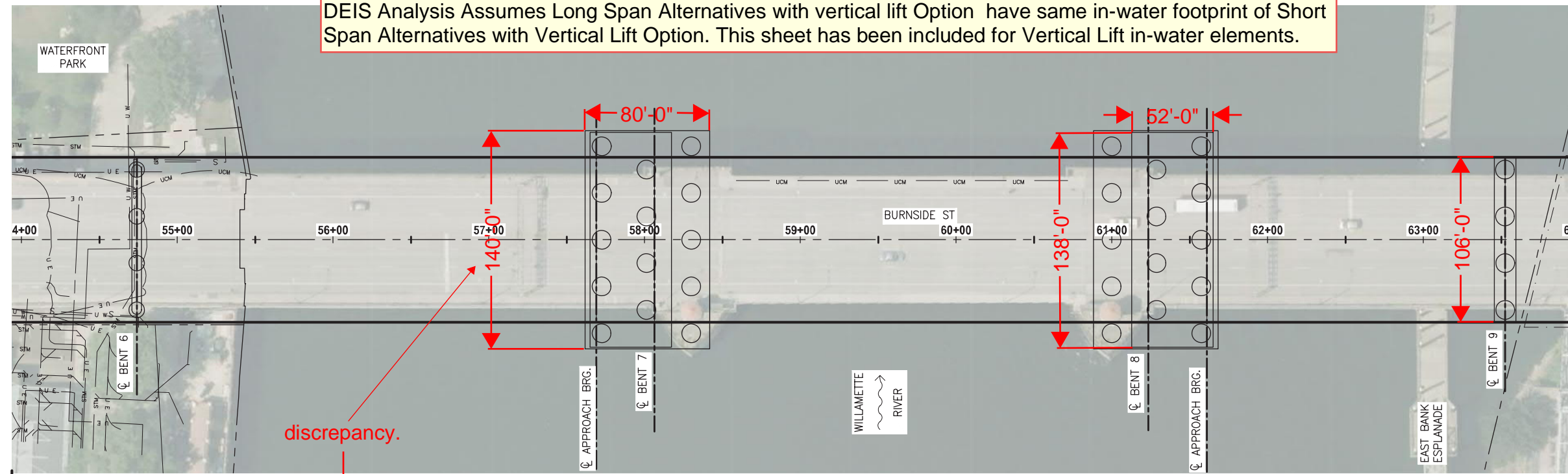

**PLAN**  
SCALE: 1"=40'  
2292'-0"  $\phi$  TO  $\phi$  BEARINGS ALONG BURNSIDE STREET

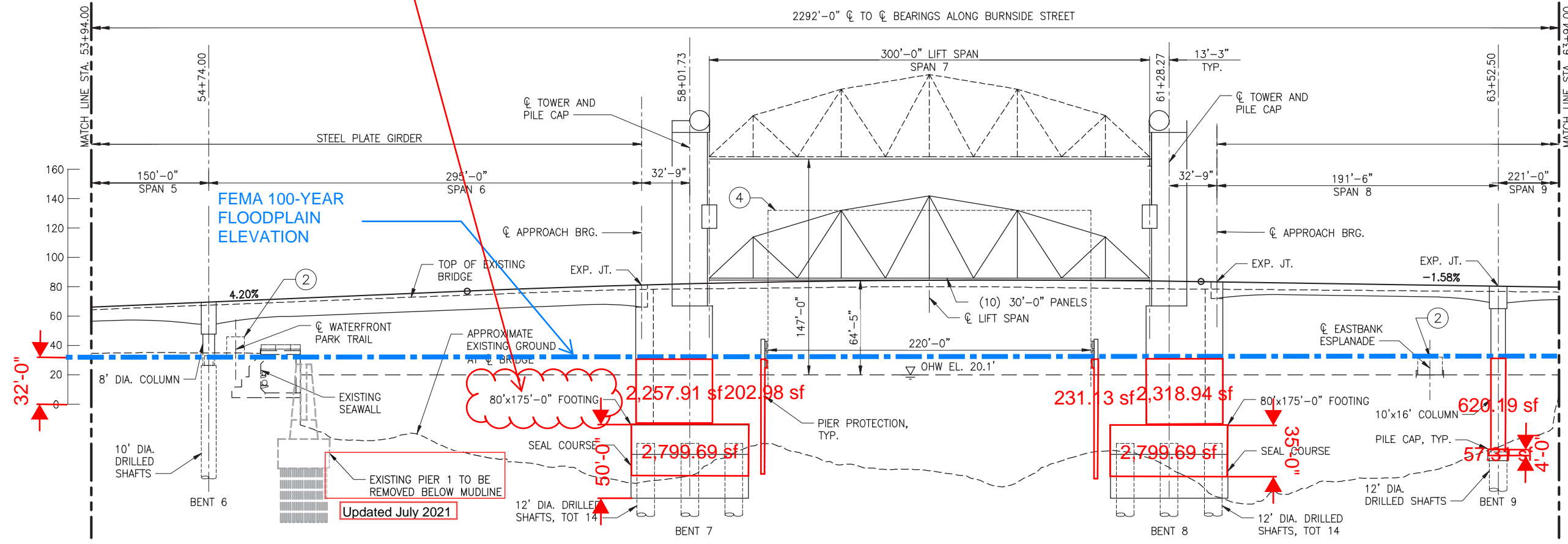

**ELEVATION**  
SCALE: 1"=40'

**CLEARANCE ENVELOPE LEGEND**

①	LRT	15'-6"	⑤	HIGHWAY	17'-4"
②	PEDESTRIAN	12'-0"	⑥	UPRR	23'-6"
③	CITY STREET	18'-0"	⑦	CITY STREET	13'-8"
④	NAVIGATION	220'-0" W x 147'-0" H			

CONCEPTUAL PLANS  
JUNE 2020

Updated July 2021

discrepancy.

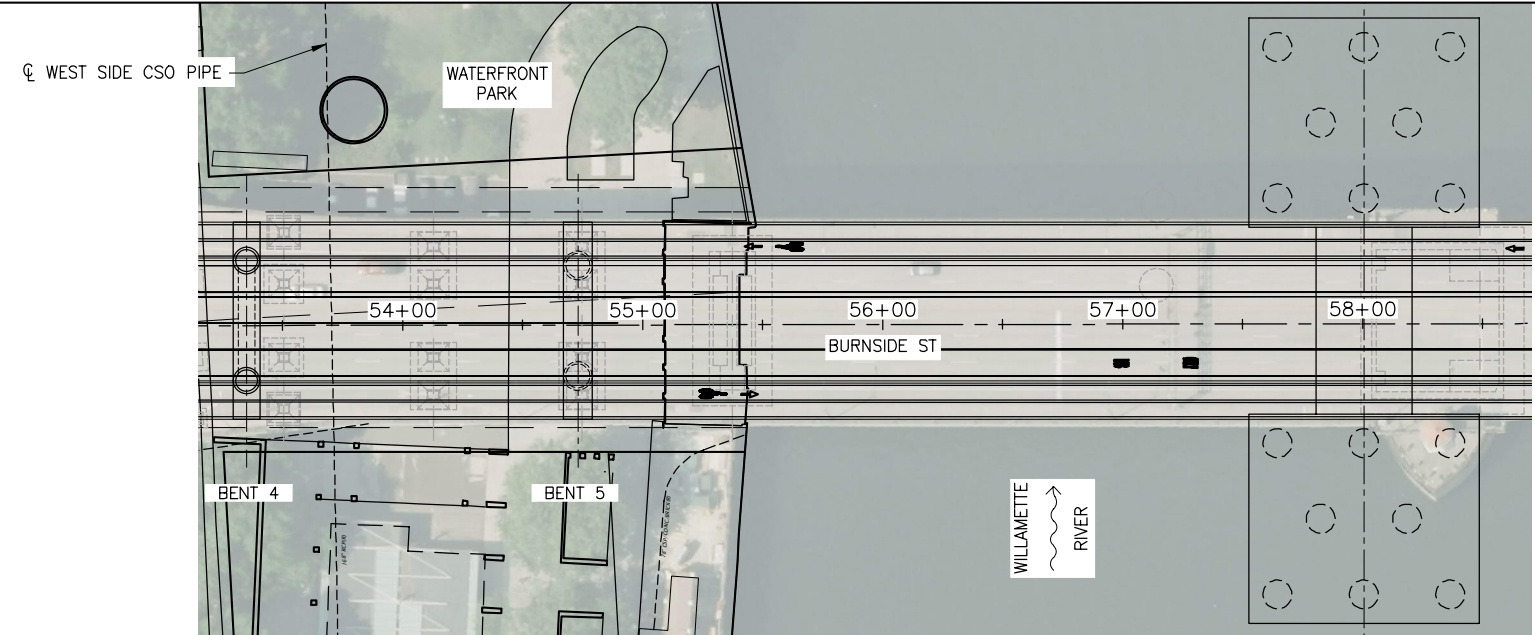

**PLAN**  
SCALE: 1"=40'

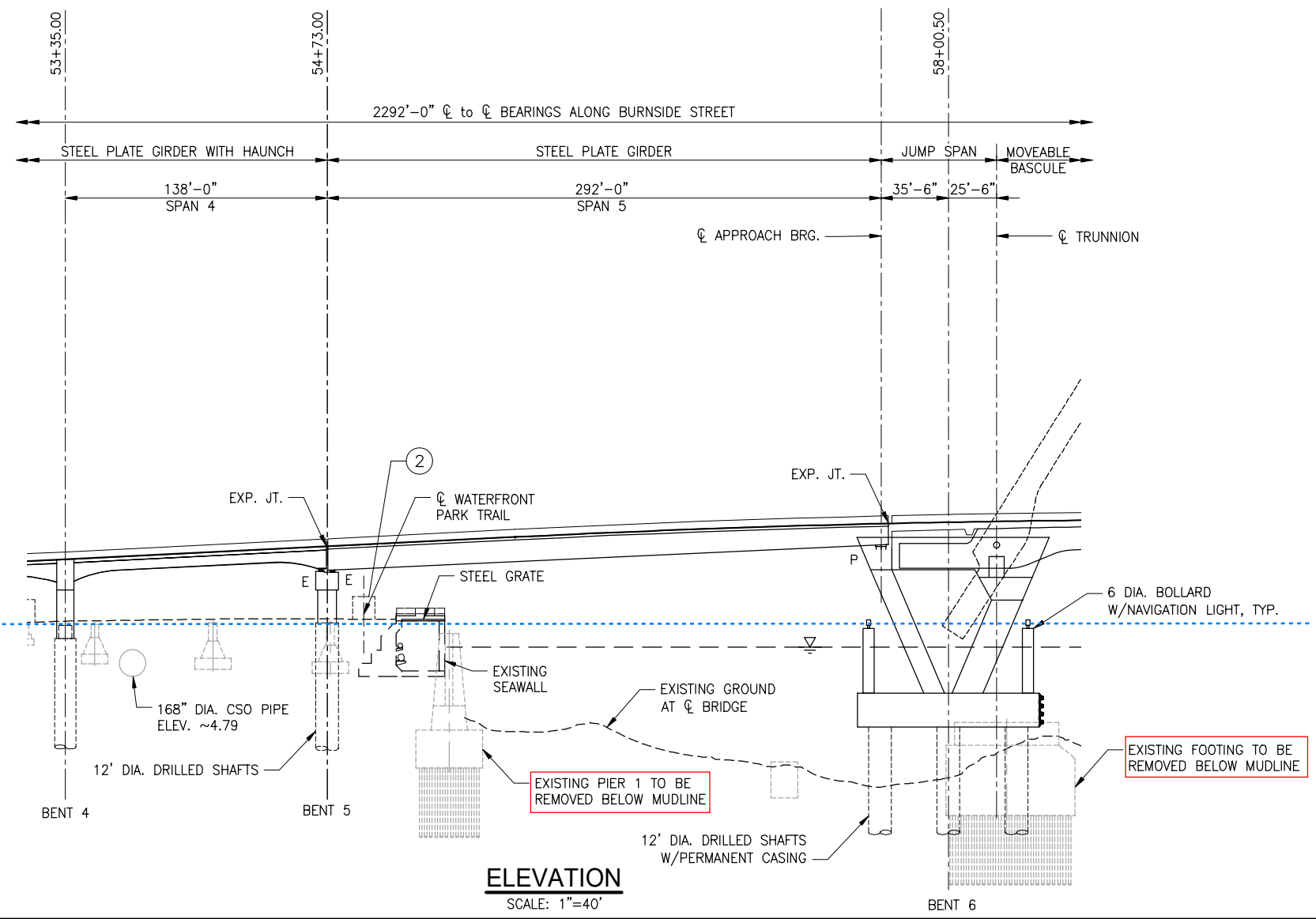

**ELEVATION**  
SCALE: 1"=40'

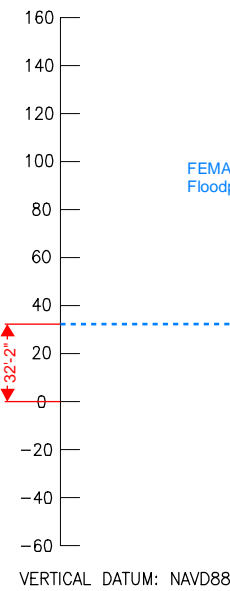

**CLEARANCE ENVELOPE LEGEND**

①	LRT	15'-6"
②	PEDESTRIAN	12'-0"
③	CITY STREET	18'-0"
④	NAVIGATION	220'-0" W x 147'-0" H
⑤	HIGHWAY	17'-4"
⑥	UPRR	23'-6"
⑦	CITY STREET @ 3rd AVE	13'-8"

Earthquake Ready Burnside Bridge  
Replacement Movable Bridge (Bascule) With Long-Span Cable Approach on Existing Alignment  
MULTNOMAH COUNTY  
DATE: 07/2021 PROJECT NO.:

**MULTNOMAH COUNTY**  
DEPARTMENT OF COMMUNITY SERVICES  
TRANSPORTATION DIVISION  
1620 S.E. 190th AVE. PORTLAND, ORE. 97233-5999

COUNTY ENGINEER

DESIGNED BY: \_\_\_\_\_  
DRAFTED BY: \_\_\_\_\_  
CHECKED BY: \_\_\_\_\_

**REVISIONS**

NO.	DATE:	DESCRIPTION:

**CONCEPTUAL PLANS**  
JULY 2021

Sheet No. **BR03**

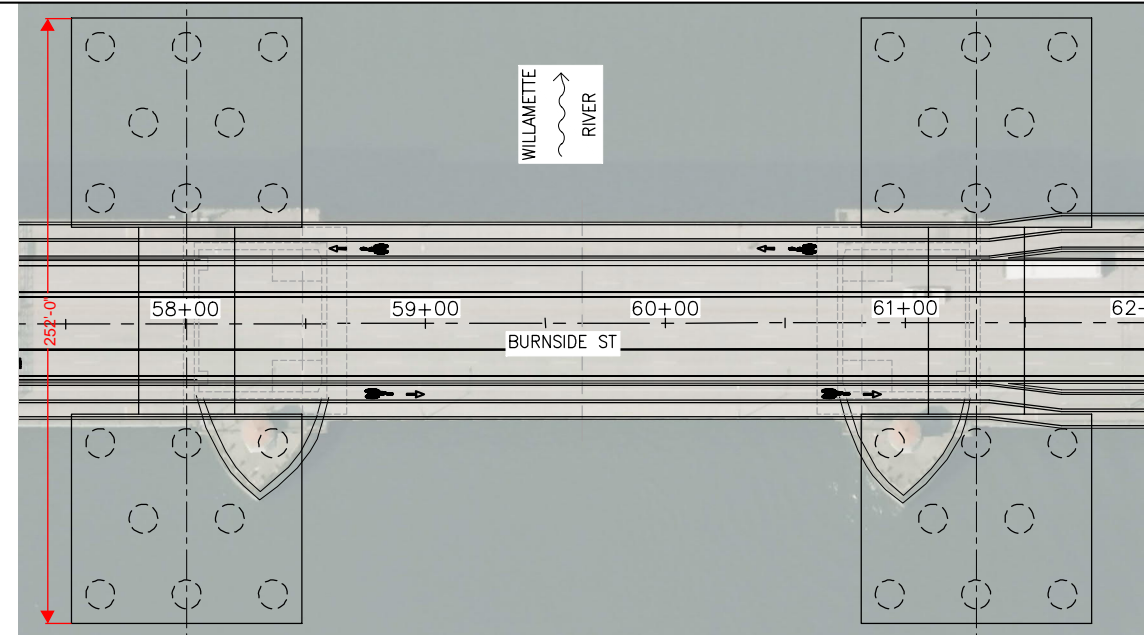

**PLAN**  
SCALE: 1"=40'

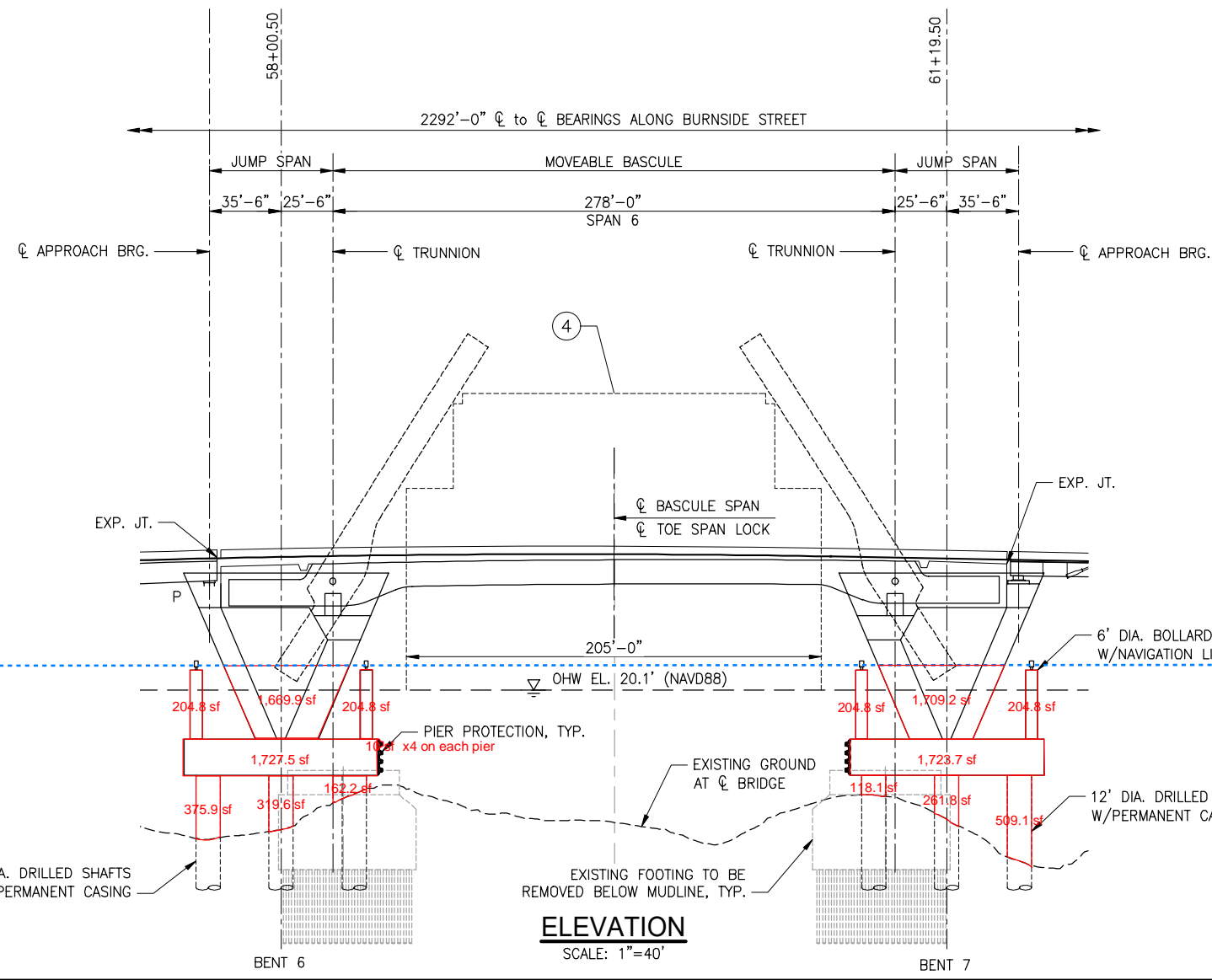

**ELEVATION**  
SCALE: 1"=40'

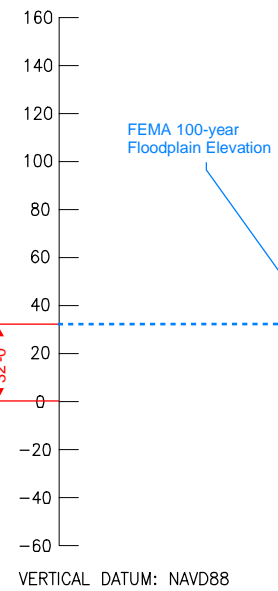

CLEARANCE ENVELOPE LEGEND

①	LRT	15'-6"
②	PEDESTRIAN	12'-0"
③	CITY STREET	18'-0"
④	NAVIGATION	220'-0" W x 147'-0" H
⑤	HIGHWAY	17'-4"
⑥	UPRR	23'-6"
⑦	CITY STREET @ 3rd AVE	13'-8"

Earthquake Ready Burnside Bridge  
Replacement Movable Bridge (Bascule) With Long-Span Cable Approach on Existing Alignment  
MULTNOMAH COUNTY  
DATE: 07/2021 PROJECT NO.:

MULTNOMAH COUNTY  
DEPARTMENT OF COMMUNITY SERVICES  
TRANSPORTATION DIVISION  
1620 S.E. 190th AVE. PORTLAND, ORE. 97233-5999

COUNTY ENGINEER

DESIGNED BY:	
DRAFTED BY:	
CHECKED BY:	

REVISIONS	NO.	DATE:	

**CONCEPTUAL PLANS**  
JULY 2021

Sheet No. **BR04**

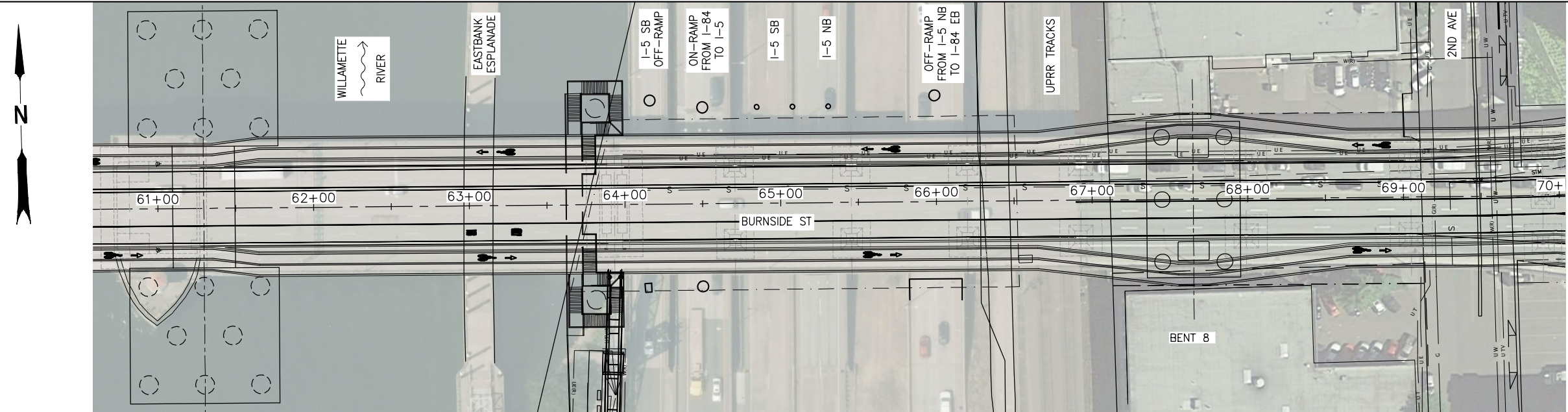

**PLAN**  
SCALE: 1"=40'

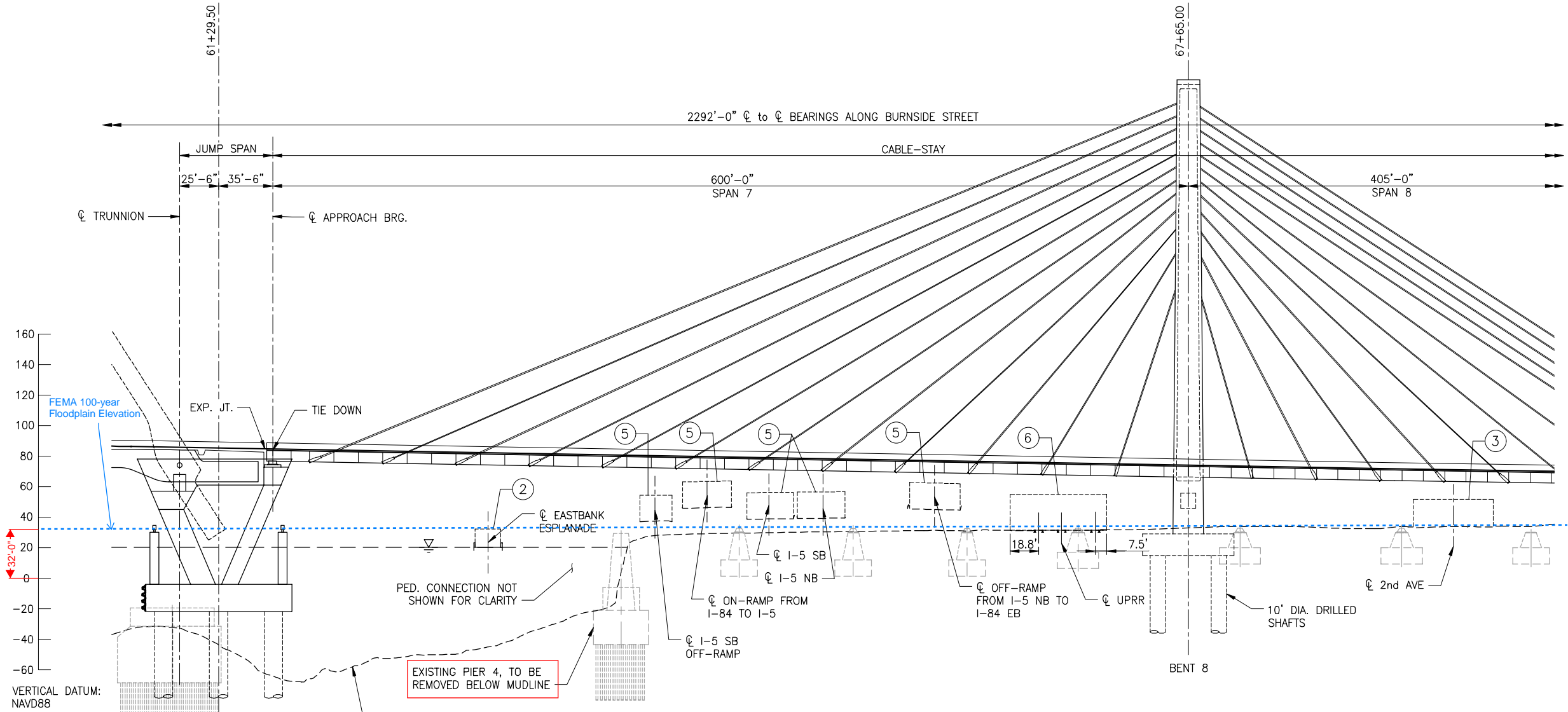

**ELEVATION**  
SCALE: 1"=40'

**CLEARANCE ENVELOPE LEGEND**

①	LRT	15'-6"
②	PEDESTRIAN	12'-0"
③	CITY STREET	18'-0"
④	NAVIGATION	220'-0" W x 147'-0" H
⑤	HIGHWAY	17'-4"
⑥	UPRR	23'-6"
⑦	CITY STREET @ 3rd AVE	13'-8"

Earthquake Ready Burnside Bridge  
Replacement Movable Bridge (Bascule) With Long-Span Cable Approach on Existing Alignment  
MULTNOMAH COUNTY  
DATE: 07/2021 PROJECT NO.:

**MULTNOMAH COUNTY**  
DEPARTMENT OF COMMUNITY SERVICES  
TRANSPORTATION DIVISION  
1620 S.E. 190th AVE. PORTLAND, ORE. 97233-5999

COUNTY ENGINEER

DESIGNED BY: \_\_\_\_\_  
DRAFTED BY: \_\_\_\_\_  
CHECKED BY: \_\_\_\_\_

**REVISIONS**

NO.	DATE:		

**CONCEPTUAL PLANS**  
JULY 2021

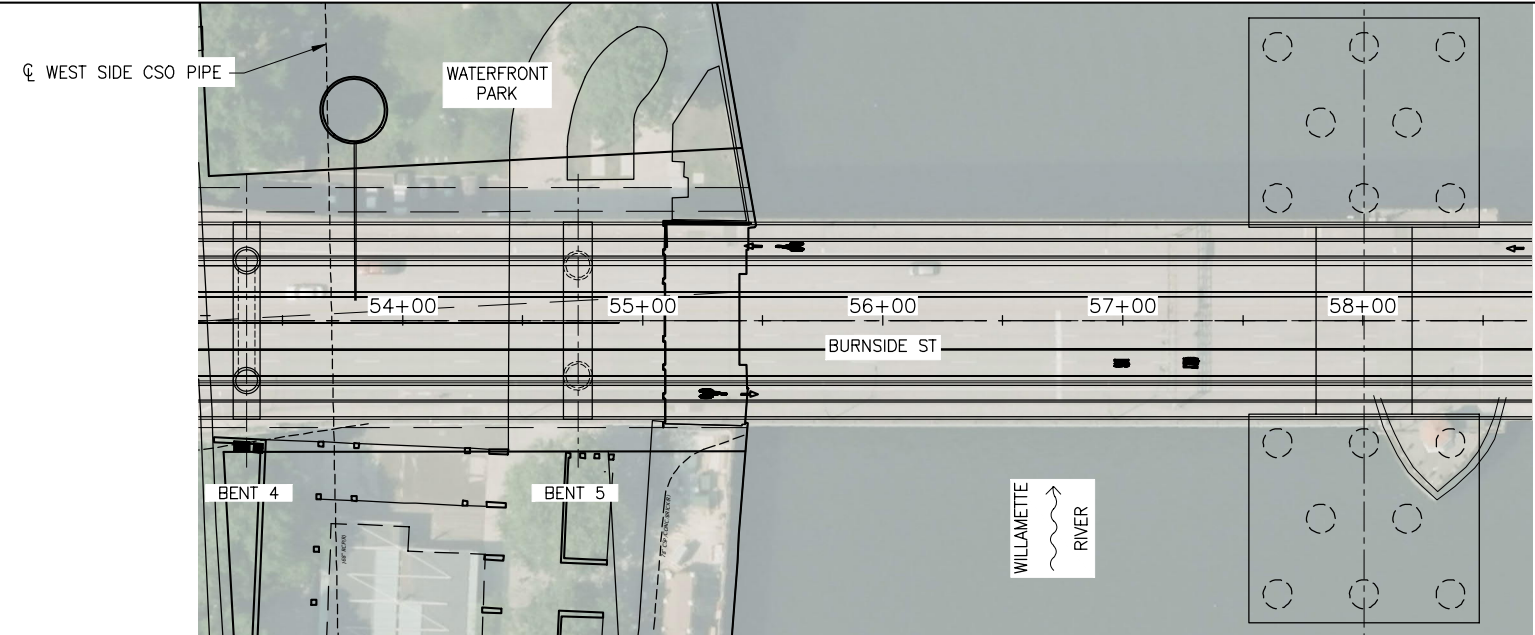

**PLAN**  
SCALE: 1"=40'

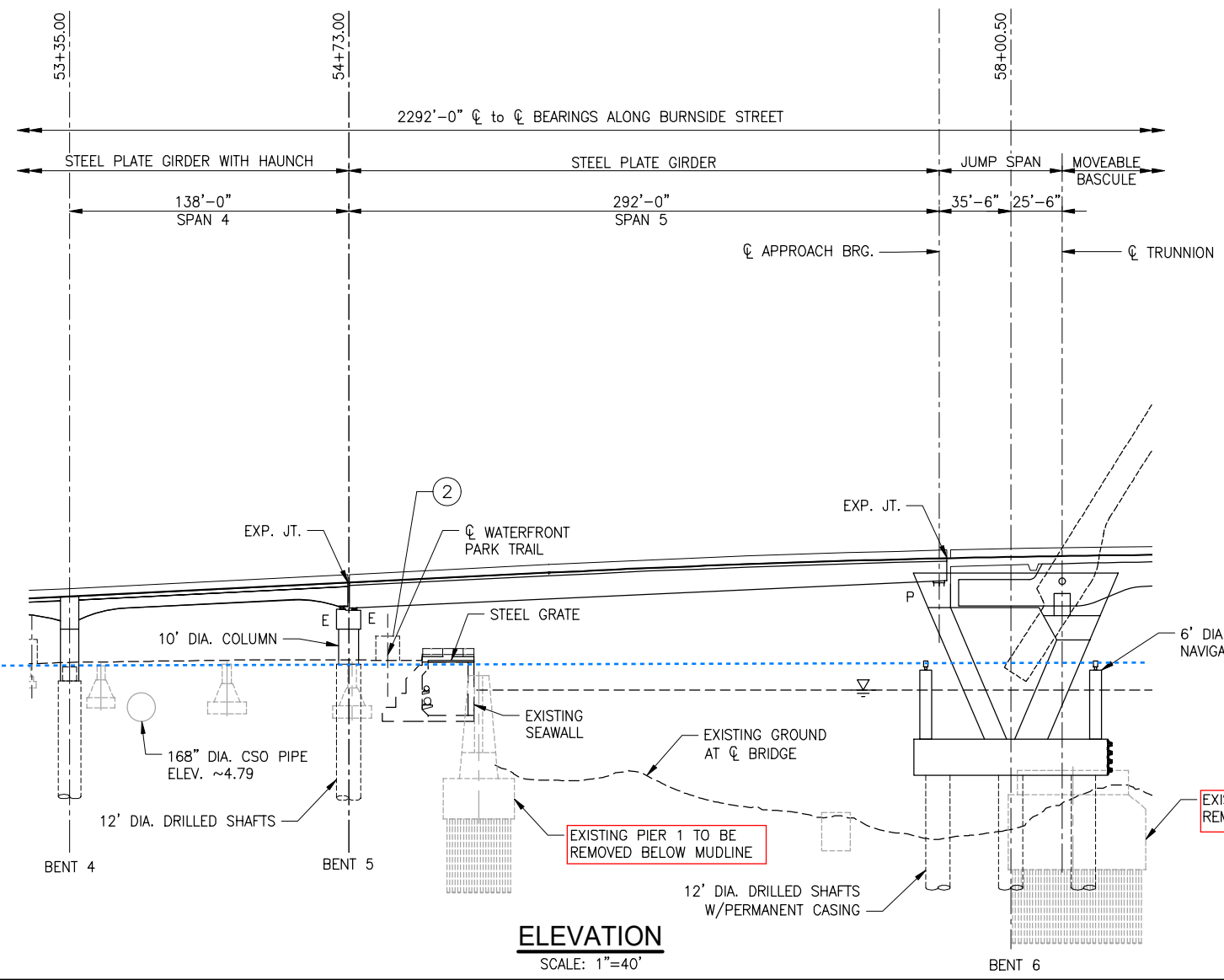

**ELEVATION**  
SCALE: 1"=40'

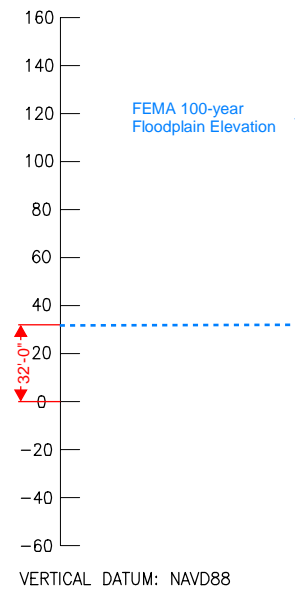

**CLEARANCE ENVELOPE LEGEND**

①	LRT	15'-6"
②	PEDESTRIAN	12'-0"
③	CITY STREET	18'-0"
④	NAVIGATION	220'-0" W x 147'-0" H
⑤	HIGHWAY	17'-4"
⑥	UPRR	23'-6"
⑦	CITY STREET @ 3rd AVE	13'-8"

Earthquake Ready Burnside Bridge  
 Replacement Alternative with  
 Long Short-span Approach (Bascule)  
 MULTNOMAH COUNTY  
 DATE: 07/2021 | PROJECT NO.:

MULTNOMAH COUNTY  
 DEPARTMENT OF COMMUNITY SERVICES  
 TRANSPORTATION DIVISION  
 1620 S.E. 190th AVE. PORTLAND, ORE. 97233-5999

COUNTY ENGINEER

DESIGNED BY:	
DRAFTED BY:	
CHECKED BY:	
NO. DATE:	
REVISIONS	

**CONCEPTUAL PLANS**  
 JULY 2021

Sheet No.  
**BR03**



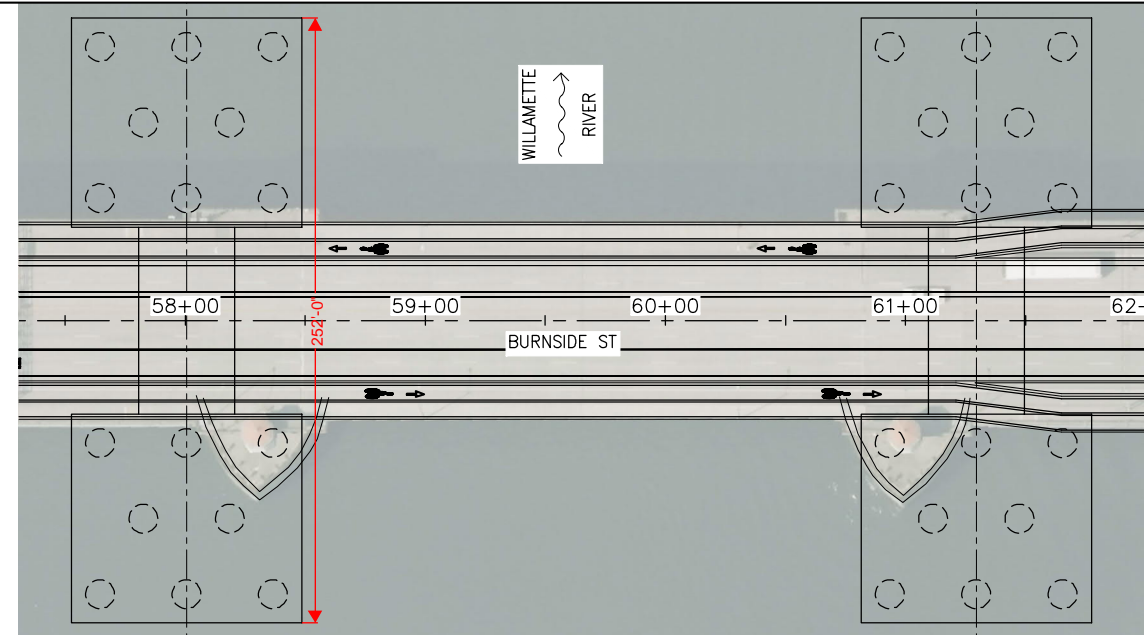

**PLAN**  
SCALE: 1"=40'

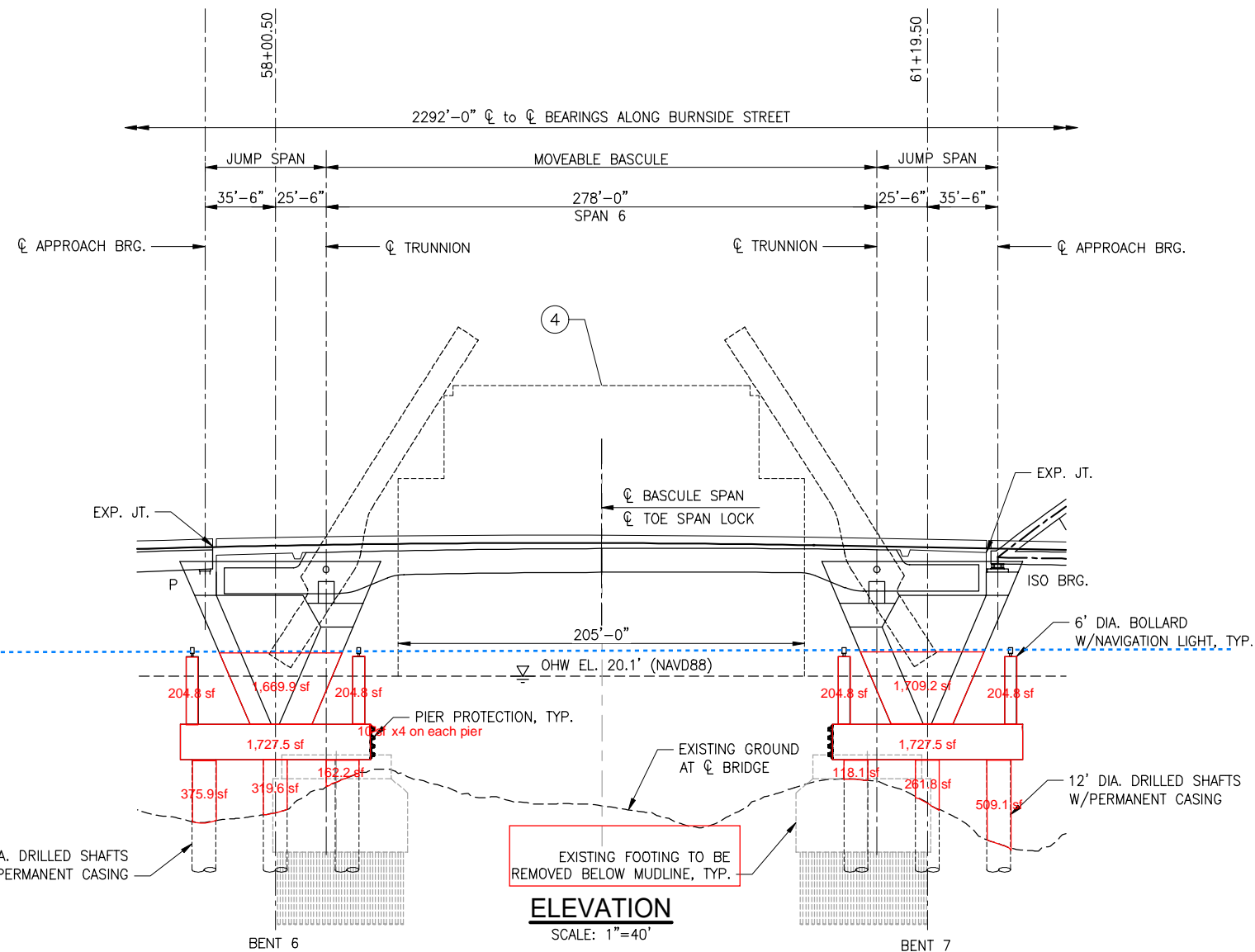

**ELEVATION**  
SCALE: 1"=40'

CLEARANCE ENVELOPE LEGEND

①	LRT	15'-6"
②	PEDESTRIAN	12'-0"
③	CITY STREET	18'-0"
④	NAVIGATION	205'W x 120'H 159'W x 162'H 150'W x 167'H
⑤	HIGHWAY	17'-4"
⑥	UPRR	23'-6"
⑦	CITY STREET @ 3rd AVE	13'-8"

Earthquake Ready Burnside Bridge  
Replacement Alternative with Long-span  
Tied Arch Approach (Bascule)  
MULTNOMAH COUNTY  
DATE: 07/2021 PROJECT NO.:

MULTNOMAH COUNTY  
DEPARTMENT OF COMMUNITY SERVICES  
TRANSPORTATION DIVISION  
1620 S.E. 190th AVE. PORTLAND, ORE. 97233-5999  
COUNTY ENGINEER

DESIGNED BY:	
DRAFTED BY:	
CHECKED BY:	
NO. DATE:	
Sheet No.	BR04

**CONCEPTUAL PLANS**  
JULY 2021

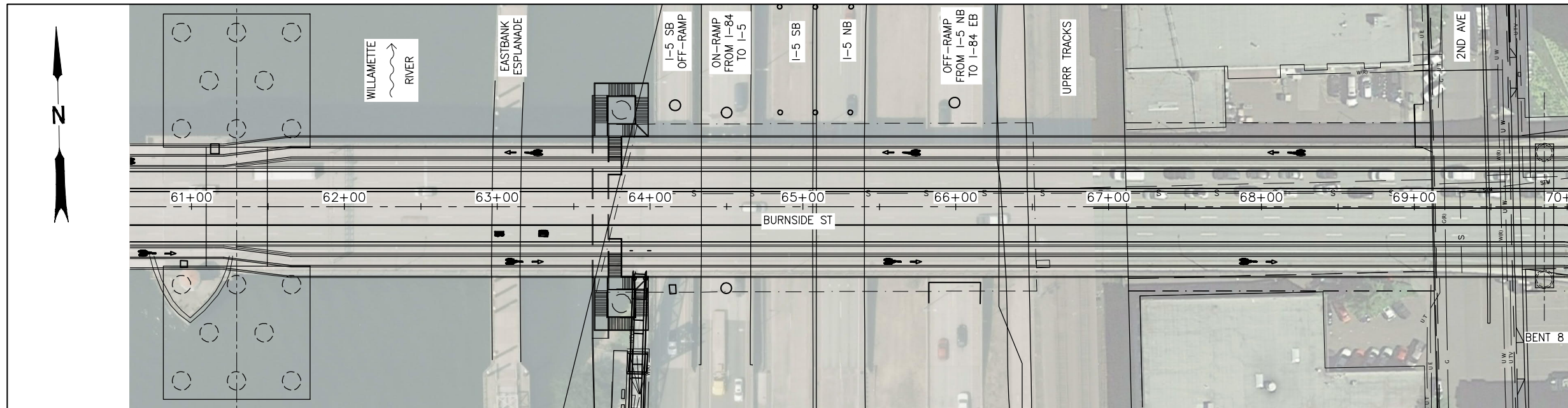

**PLAN**  
SCALE: 1"=40'

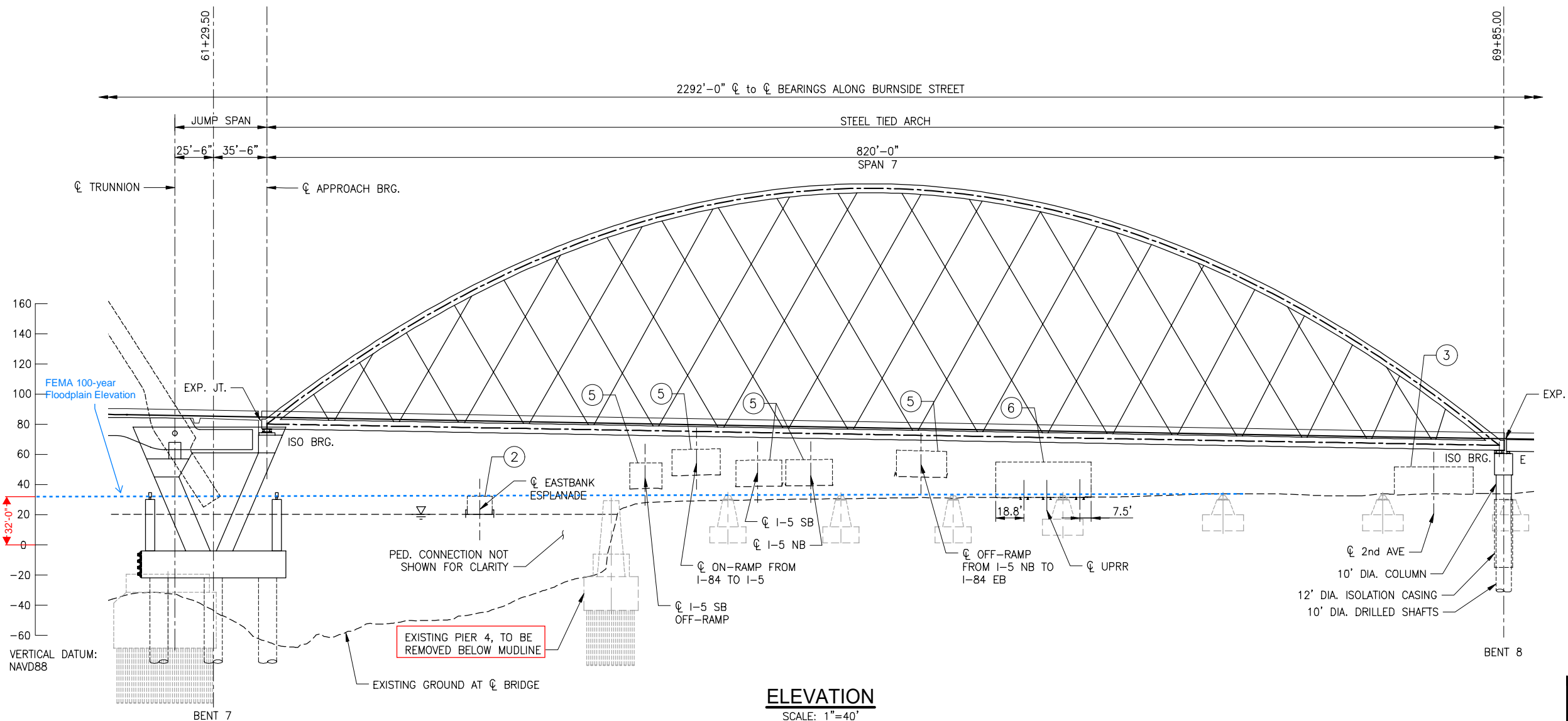

**ELEVATION**  
SCALE: 1"=40'

**CLEARANCE ENVELOPE LEGEND**

①	LRT	15'-6"
②	PEDESTRIAN	12'-0"
③	CITY STREET	18'-0"
④	NAVIGATION	220'-0" W x UNLIMITED H
⑤	HIGHWAY	17'-4"
⑥	UPRR	23'-6"
⑦	CITY STREET @ 3rd AVE	13'-8"

**CONCEPTUAL PLANS**  
JULY 2021

**Earthquake Ready Burnside Bridge**  
Replacement Alternative with Long Short-span Approach (Bascule)  
MULTNOMAH COUNTY  
DATE: 07/2021 PROJECT NO.:

**MULTNOMAH COUNTY**  
DEPARTMENT OF COMMUNITY SERVICES  
TRANSPORTATION DIVISION  
1620 S.E. 190th AVE. PORTLAND, ORE. 97233-5999

COUNTY ENGINEER

DESIGNED BY:	
DRAFTED BY:	
CHECKED BY:	
NO. DATE:	
Sheet No.	BR05

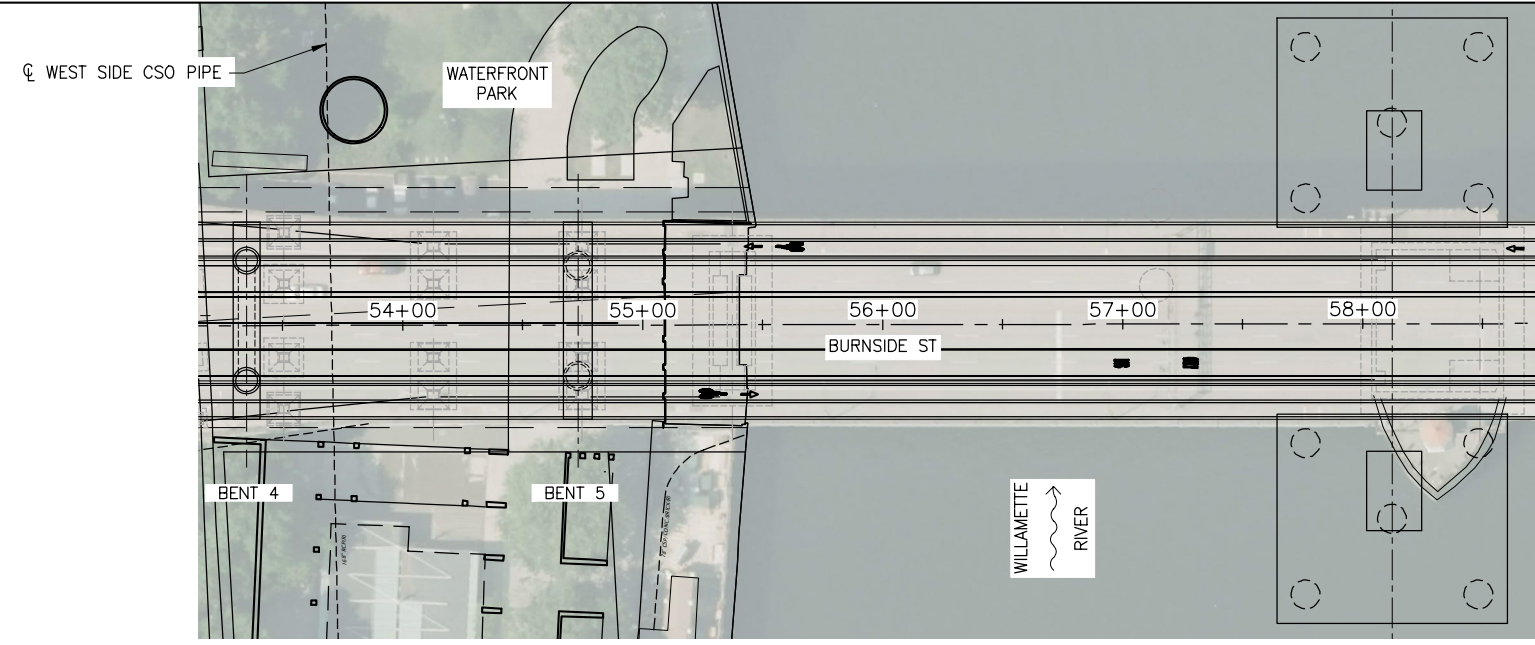

**PLAN**  
SCALE: 1"=40'

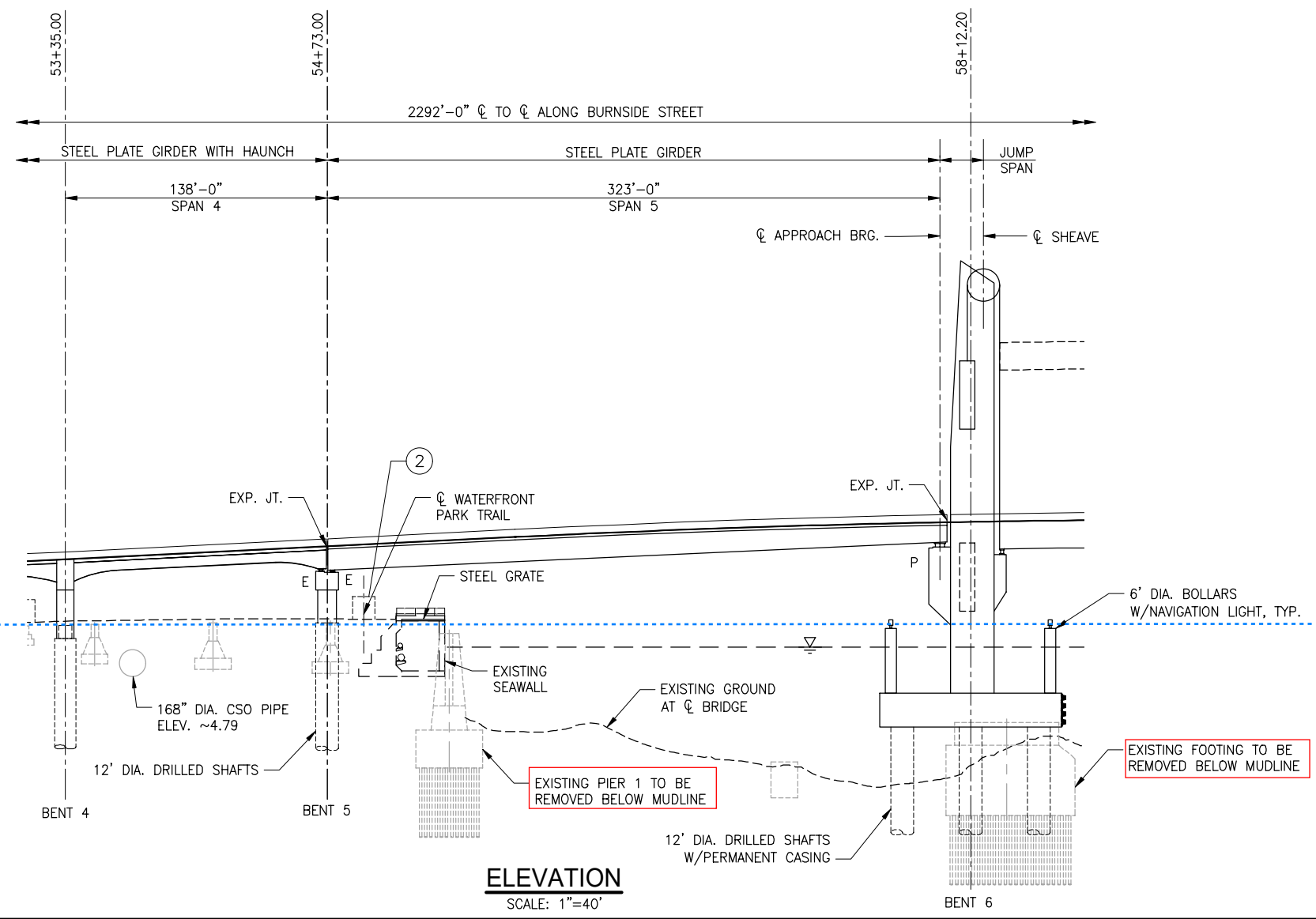

**ELEVATION**  
SCALE: 1"=40'

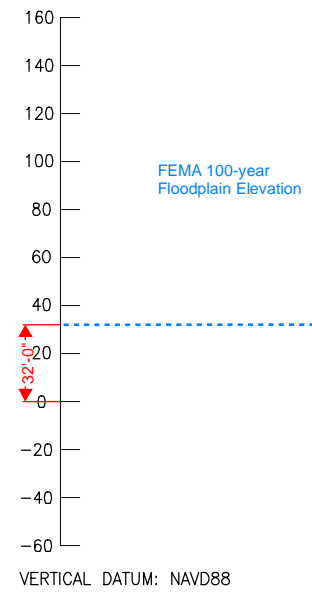

**CLEARANCE ENVELOPE LEGEND**

①	LRT	15'-6"
②	PEDESTRIAN	12'-0"
③	CITY STREET	18'-0"
④	NAVIGATION	220'-0" W x 147'-0" H
⑤	HIGHWAY	17'-4"
⑥	UPRR	23'-6"
⑦	CITY STREET @ 3rd AVE	13'-8"

Earthquake Ready Burnside Bridge  
Replacement Alternative with Long-span Approach (Lift)  
MULTNOMAH COUNTY  
DATE: 07/2021 PROJECT NO.:

**MULTNOMAH COUNTY**  
DEPARTMENT OF COMMUNITY SERVICES  
TRANSPORTATION DIVISION  
1620 S.E. 190th AVE. PORTLAND, ORE. 97233-5999

COUNTY ENGINEER

DESIGNED BY: \_\_\_\_\_  
DRAFTED BY: \_\_\_\_\_  
CHECKED BY: \_\_\_\_\_

**REVISIONS**

NO.	DATE:	DESCRIPTION:

**CONCEPTUAL PLANS**  
JULY 2021

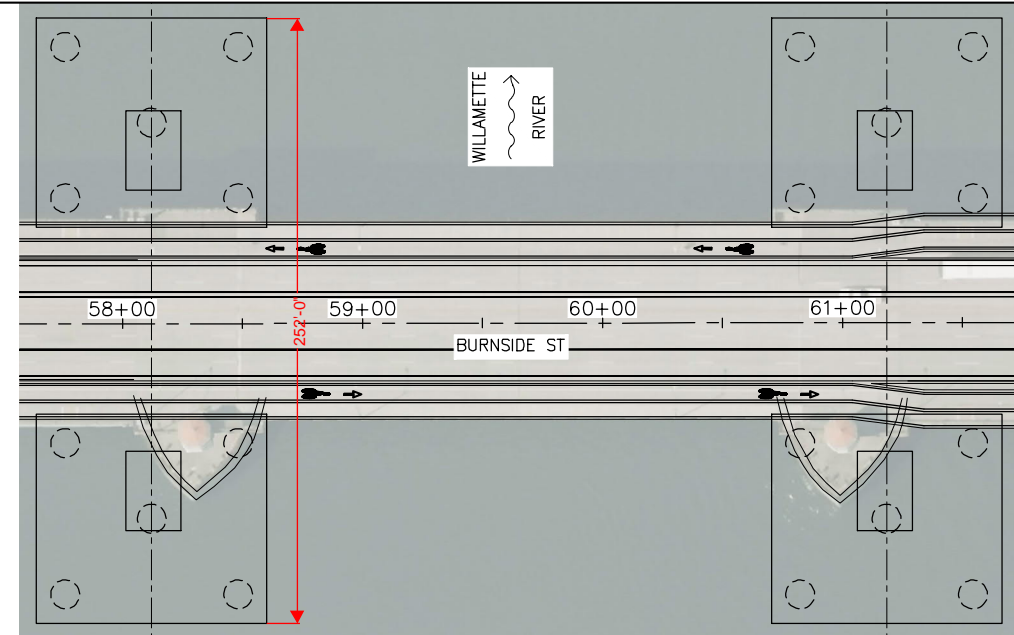

**PLAN**  
SCALE: 1"=40'

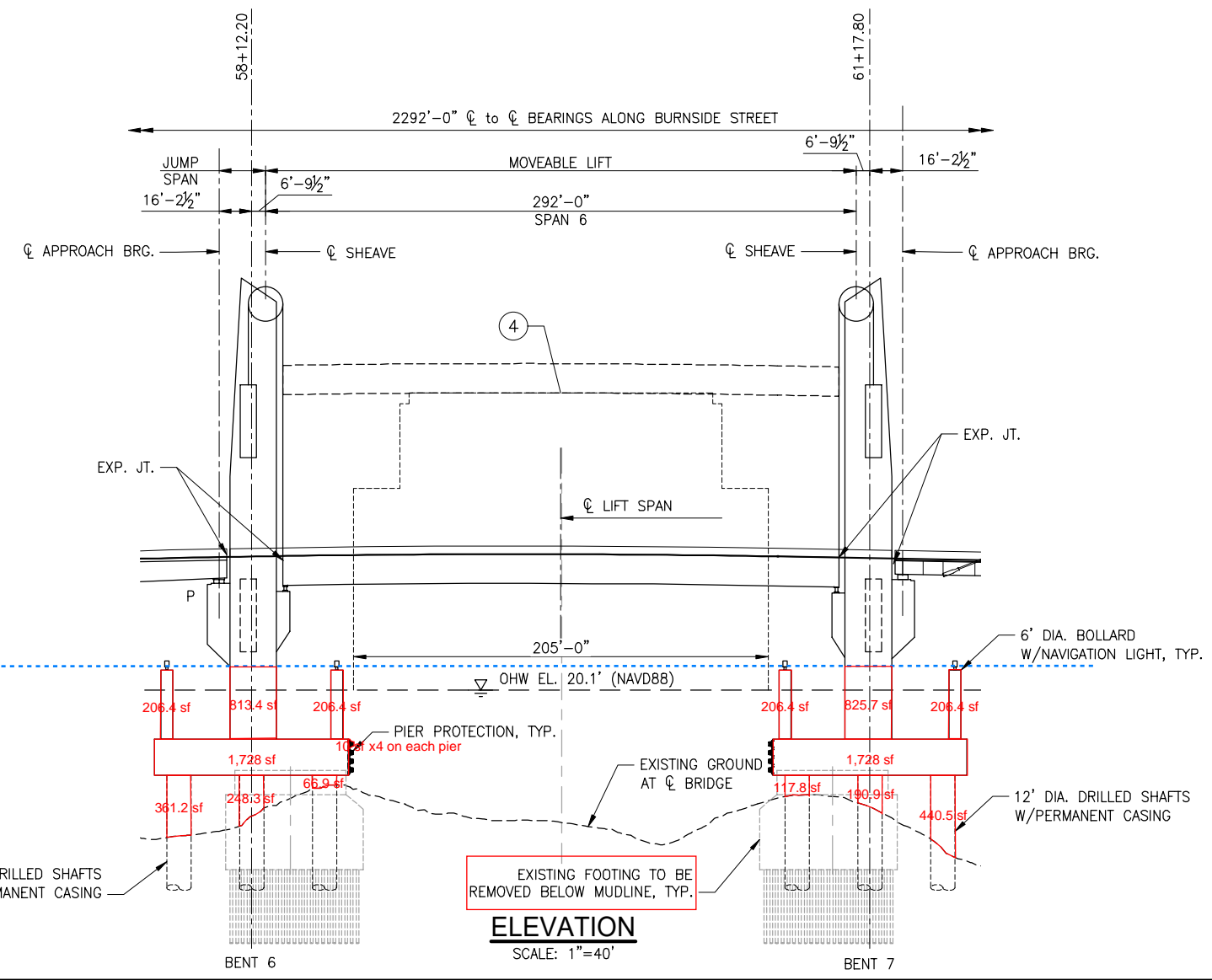

**ELEVATION**  
SCALE: 1"=40'

**CLEARANCE ENVELOPE LEGEND**

①	LRT	15'-6"
②	PEDESTRIAN	12'-0"
③	CITY STREET	18'-0"
④	NAVIGATION	220'-0" W x 147'-0" H
⑤	HIGHWAY	17'-4"
⑥	UPRR	23'-6"
⑦	CITY STREET @ 3rd AVE	13'-8"

Earthquake Ready Burnside Bridge  
Replacement Alternative with Long-span Approach (Lift)  
MULTNOMAH COUNTY  
DATE: 07/2021 PROJECT NO.:

MULTNOMAH COUNTY  
DEPARTMENT OF COMMUNITY SERVICES  
TRANSPORTATION DIVISION  
1620 S.E. 190th AVE. PORTLAND, ORE. 97233-5999  
COUNTY ENGINEER

DESIGNED BY: \_\_\_\_\_  
DRAFTED BY: \_\_\_\_\_  
CHECKED BY: \_\_\_\_\_

**REVISIONS**

NO.	DATE:	DESCRIPTION:

**CONCEPTUAL PLANS**  
JULY 2021

Sheet No. **BR04**

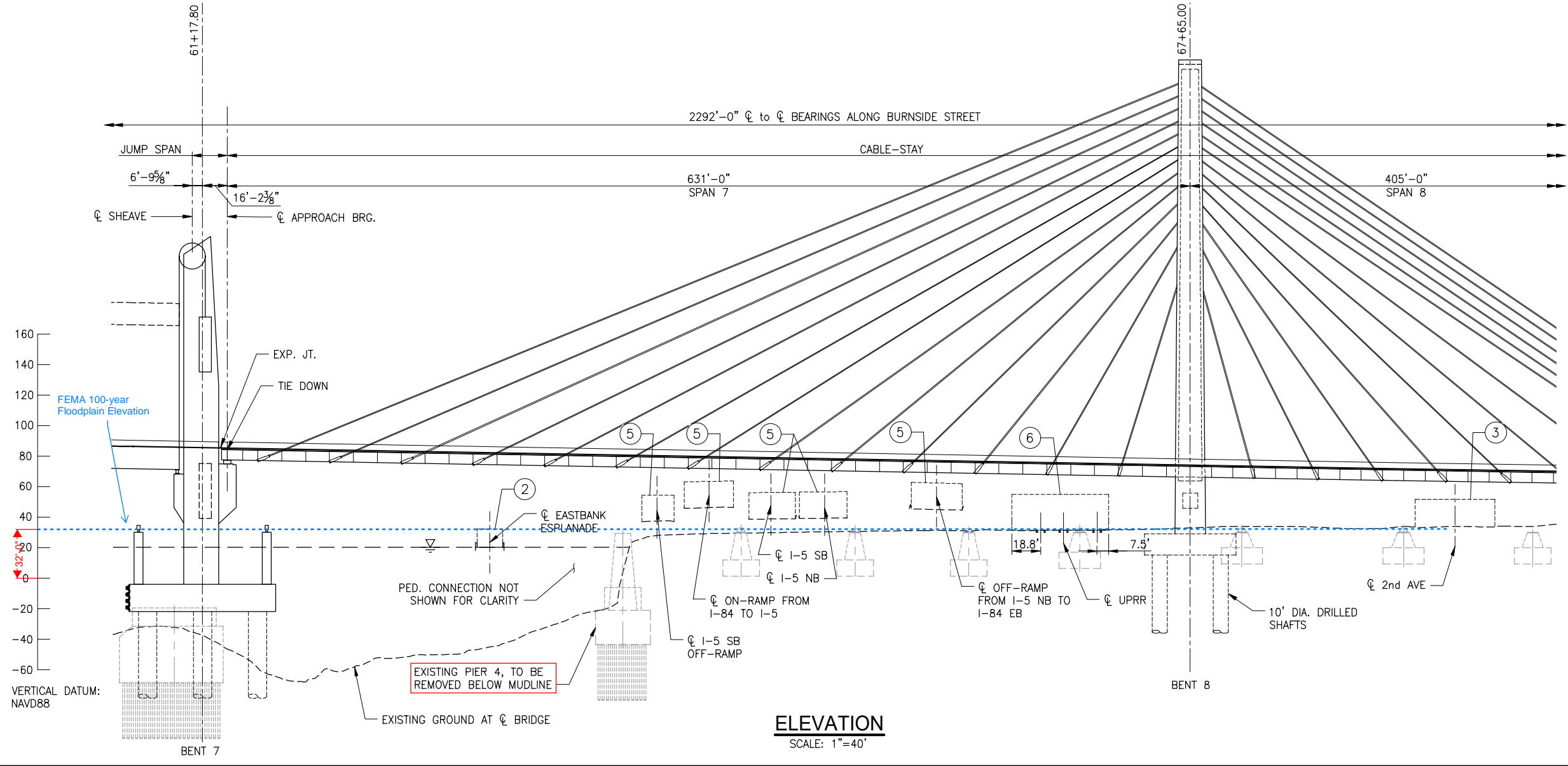
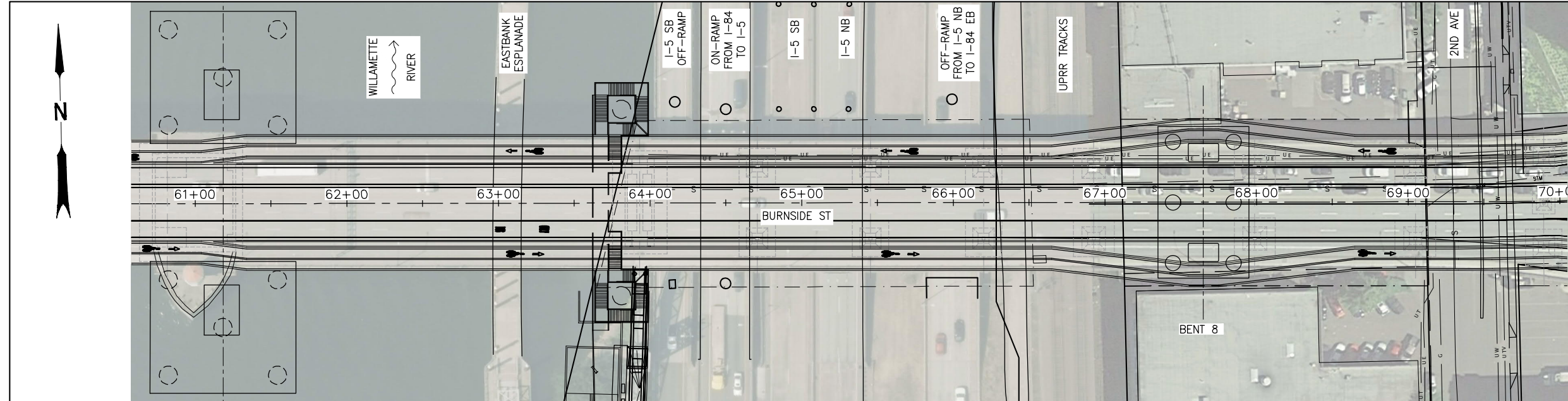

CLEARANCE ENVELOPE LEGEND

①	LRT	15'-6"
②	PEDESTRIAN	12'-0"
③	CITY STREET	18'-0"
④	NAVIGATION	220'-0" W x 147'-0" H
⑤	HIGHWAY	17'-4"
⑥	UPRR	23'-6"
⑦	CITY STREET @ 3rd AVE	13'-8"

CONCEPTUAL PLANS  
JULY 2021

Earthquake Ready Burnside Bridge  
Replacement Alternative with Long-span Approach (Lift)  
MULTNOMAH COUNTY  
DATE: 07/2021 PROJECT NO.:

MULTNOMAH COUNTY  
DEPARTMENT OF COMMUNITY SERVICES  
TRANSPORTATION DIVISION  
1620 S.E. 190th AVE. PORTLAND, ORE. 97233-5999

COUNTY ENGINEER

DESIGNED BY: \_\_\_\_\_  
DRAFTED BY: \_\_\_\_\_  
CHECKED BY: \_\_\_\_\_

REVISIONS

NO.	DATE:	DESCRIPTION:

Sheet No. **BR05**

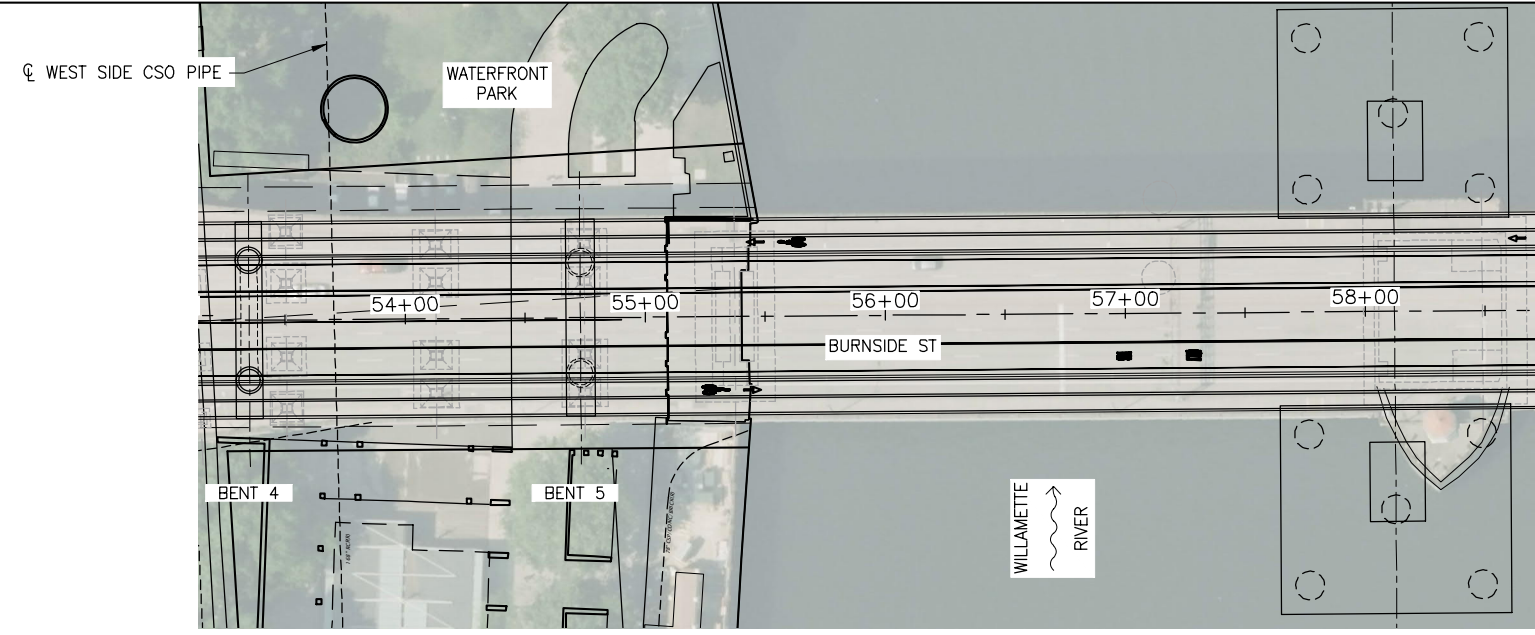

**PLAN**  
SCALE: 1"=40'

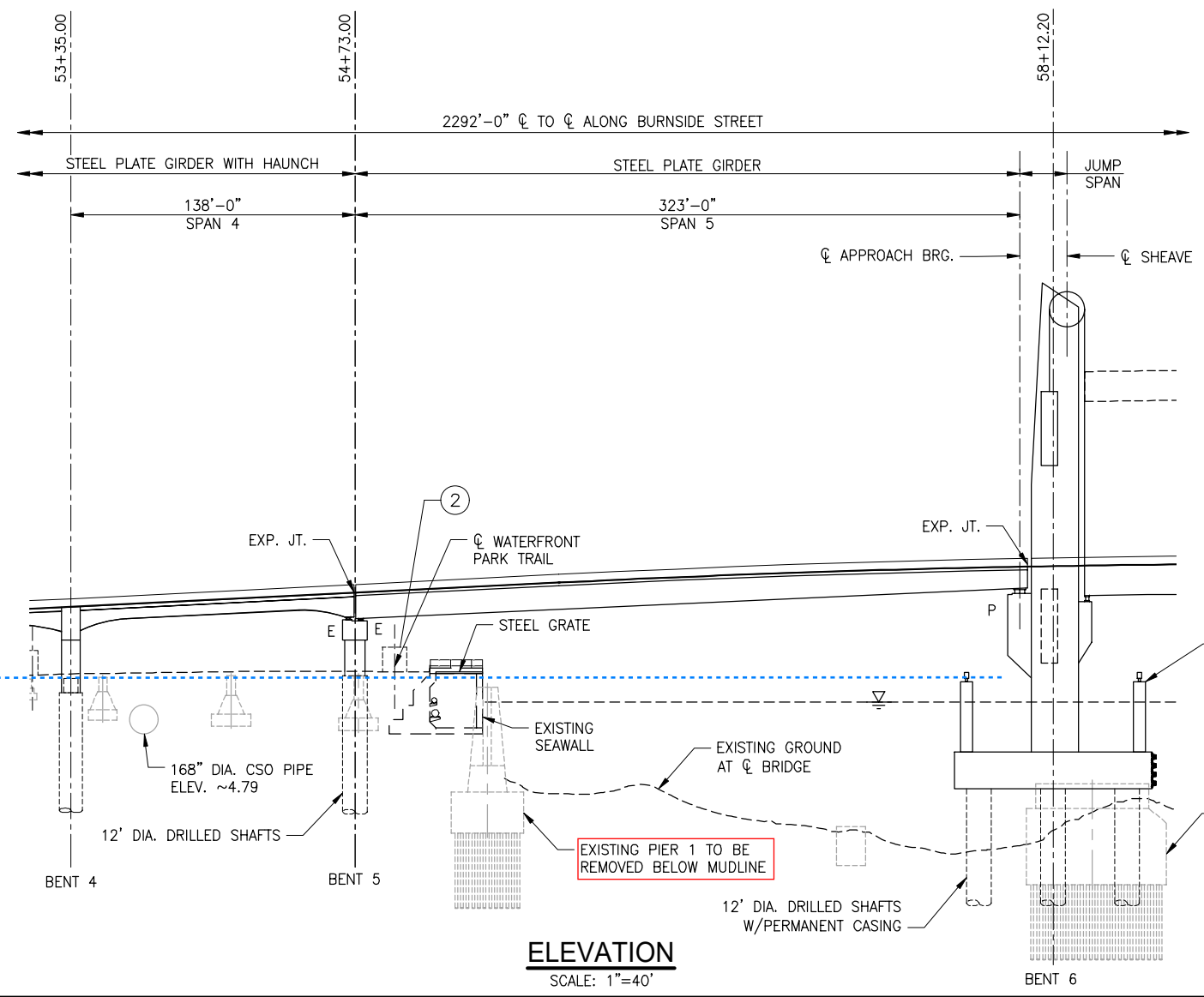

**ELEVATION**  
SCALE: 1"=40'

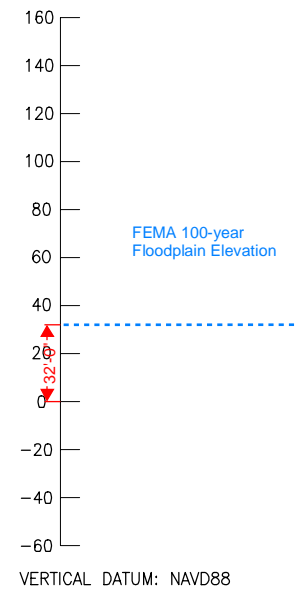

VERTICAL DATUM: NAVD88

**CLEARANCE ENVELOPE LEGEND**

①	LRT	15'-6"
②	PEDESTRIAN	12'-0"
③	CITY STREET	18'-0"
④	NAVIGATION	220'-0" W x 147'-0" H
⑤	HIGHWAY	17'-4"
⑥	UPRR	23'-6"
⑦	CITY STREET @ 3rd AVE	13'-8"

**CONCEPTUAL PLANS**  
JULY 2021

Earthquake Ready Burnside Bridge  
Replacement Alternative with  
Long Short-span Approach (Lift)  
MULTNOMAH COUNTY  
DATE: 07/2021 PROJECT NO.:

MULTNOMAH COUNTY  
DEPARTMENT OF COMMUNITY SERVICES  
TRANSPORTATION DIVISION  
1620 S.E. 190th AVE. PORTLAND, ORE. 97233-5999

COUNTY ENGINEER

DESIGNED BY:	
DRAFTED BY:	
CHECKED BY:	
NO. DATE:	
Sheet No.	BR03

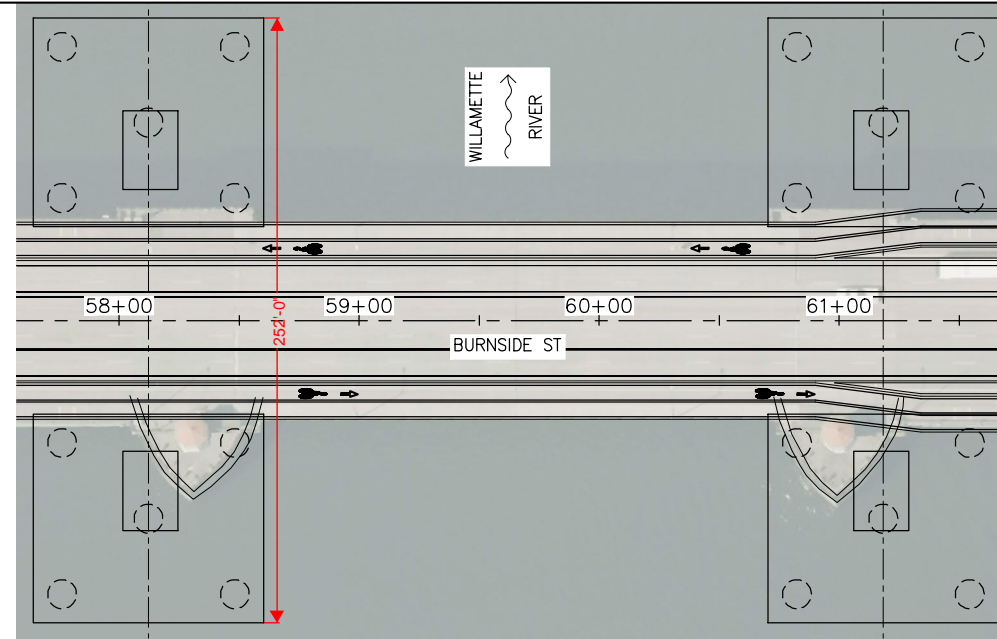

**PLAN**  
SCALE: 1"=40'

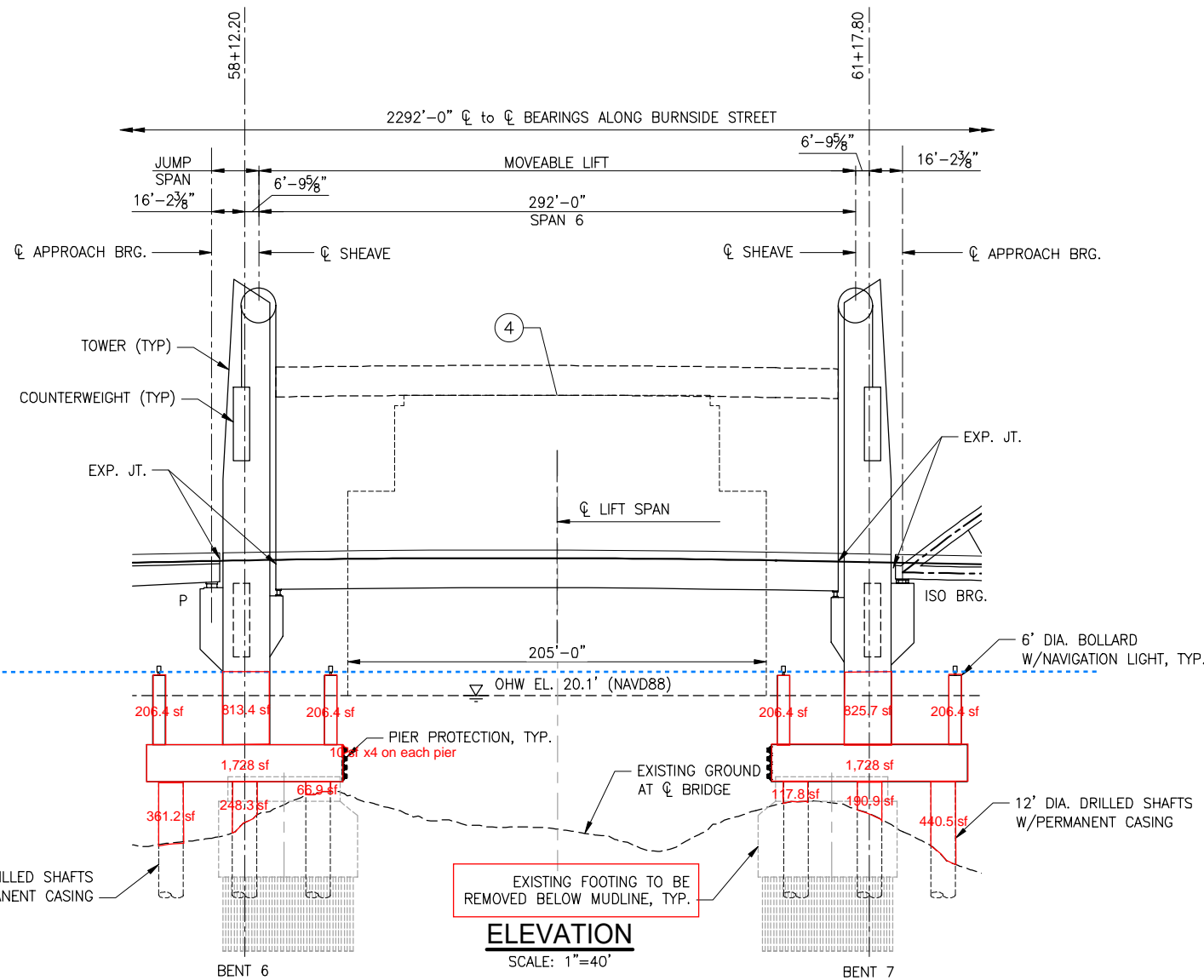

**ELEVATION**  
SCALE: 1"=40'

160  
140  
120  
100  
80  
60  
40  
20  
0  
-20  
-40  
-60

FEMA 100-year  
Floodplain Elevation

32'-0"

VERTICAL DATUM: NAVD88

CLEARANCE ENVELOPE LEGEND

①	LRT	15'-6"
②	PEDESTRIAN	12'-0"
③	CITY STREET	18'-0"
④	NAVIGATION	205'W x 120'H 159'W x 162'H 150'W x 167'H
⑤	HIGHWAY	17'-4"
⑥	UPRR	23'-6"
⑦	CITY STREET @ 3rd AVE	13'-8"

Earthquake Ready Burnside Bridge  
Replacement Movable Bridge (Bascule) With Long-Span Cable  
Approach on Existing Alignment  
MULTNOMAH COUNTY  
DATE: 07/2021 PROJECT NO.:

MULTNOMAH COUNTY  
DEPARTMENT OF COMMUNITY SERVICES  
TRANSPORTATION DIVISION  
1620 S.E. 190th AVE. PORTLAND, ORE. 97233-5999

COUNTY ENGINEER

DESIGNED BY:	
DRAFTED BY:	
CHECKED BY:	
NO. DATE:	
Sheet No.	BR04

**CONCEPTUAL PLANS**  
JULY 2021

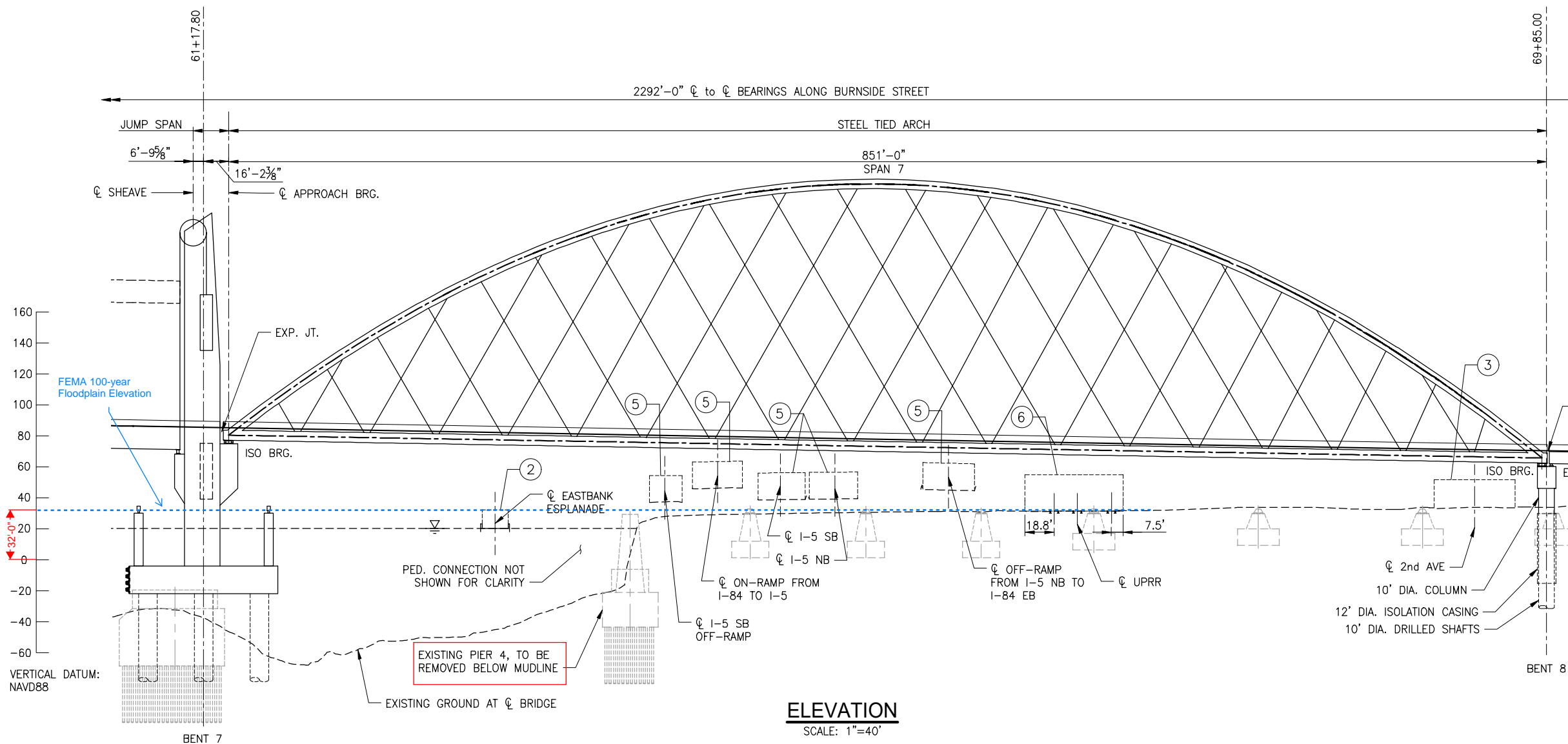
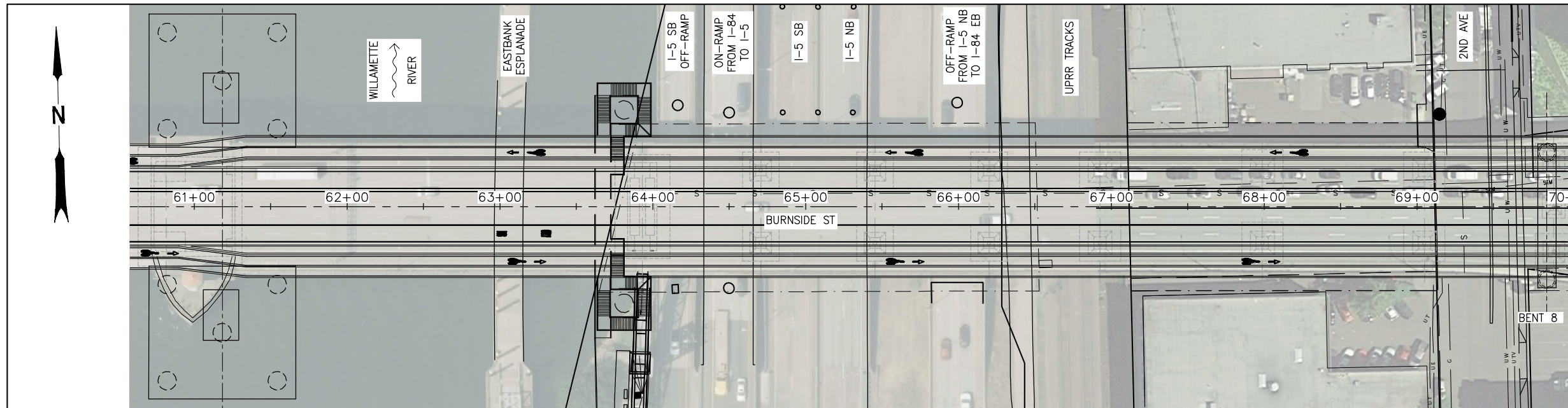

CLEARANCE ENVELOPE LEGEND

①	LRT	15'-6"
②	PEDESTRIAN	12'-0"
③	CITY STREET	18'-0"
④	NAVIGATION	220'-0" W x 147'-0" H
⑤	HIGHWAY	17'-4"
⑥	UPRR	23'-6"
⑦	CITY STREET @ 3rd AVE	13'-8"

Earthquake Ready Burnside Bridge  
Replacement Alternative with Long Short-span Approach (Lift)  
MULTNOMAH COUNTY  
DATE: 07/2021 PROJECT NO.:

MULTNOMAH COUNTY  
DEPARTMENT OF COMMUNITY SERVICES  
TRANSPORTATION DIVISION  
1620 S.E. 190th AVE. PORTLAND, ORE. 97233-5999

COUNTY ENGINEER

DESIGNED BY: \_\_\_\_\_  
DRAFTED BY: \_\_\_\_\_  
CHECKED BY: \_\_\_\_\_

NO. DATE: \_\_\_\_\_

REVISIONS

Sheet No. **BR05**

CONCEPTUAL PLANS  
JULY 2021



## Floodplain Impacts Outside of the Floodway

Existing  
 West Approach

Existing  
 East Approach

Support Locations	Number of Shafts or Columns*	Shaft Diameter (feet)	Column Diameter (feet)	Total Bent width parallel to river (feet)	Support Locations	Number of Shafts or Columns*	Shaft Diameter (feet)	Column Diameter (feet)	Total Bent width parallel to river (feet)	Alternative Total Bent width parallel to River (feet)
										241
Bent 1	Abutment				Bent 21	2	NA	2	4	
Bent 2	4	NA	2	8	Bent 22	2	NA	2	4	
Bent 3	4	NA	2	8	Bent 23	2	NA	2	4	
Bent 4	4	NA	2	8	Bent 24	2	NA	2	4	
Bent 5	4	NA	2	8	Bent 25	2	NA	2	4	
Bent 6	4	NA	2	8	Bent 26	2	NA	2	4	
Bent 7	4	NA	2	8	Bent 27	3	NA	2	6	
Bent 8	4	NA	2	8	Bent 28	3	NA	5	15	
Bent 9	4	NA	2	8	Bent 29	4	NA	2	8	
Bent 10	4	NA	2	8	Bent 30	4	NA	2	8	
Bent 11	4	NA	2	8	Bent 31	4	NA	2	8	
Bent 12	4	NA	2	8	Bent 32	4	NA	2	8	
Bent 13	4	NA	2	8	Bent 33	4	NA	3	12	
Bent 14	4	NA	3	12	Bent 34	4	NA	3	12	
Bent 15	4	NA	3	12	Bent 35	Abutment				
Bent 16	4	NA	3	12	Totals:	26		23	61	
Bent 17	4	NA	4	16						
Bent 18	4	NA	4	16						
Bent 19	4	NA	4	16						
Totals:	72		45	180						

\*outside boundaries of the API and excluded from totals

Assumptions/Sources:  
 \*References the number of shafts or columns that are above the mudline with potential to create an obstruction to flow.  
 \*Measured bent widths from elevation view of Paint and Rehab project plan sets (2017) using Bluebeam.  
 \* Number of shafts from Plan View of As Builts (1924)  
 \*Assume all footings in West Approach are fully buried in the ground  
 \*Assume all footings in East Approach are fully buried in the ground  
 \*Measured the distance from the centerline of 2nd Ave to the boundary extent of the 500 year floodplain to be 190 ft. marked this boundary on the plan sheet to eliminate bents outside the floodplain.

### DEIS Long-span Approaches- Tied Arch

#### West Approach

#### East Approach

Support Locations	Number of Shafts or Columns*	Shaft Diameter (feet)	Column Diameter (feet)	Total Bent width parallel to river (feet)	Support Locations	Number of Shafts or Columns*	Shaft Diameter (feet)	Column Diameter (feet)	Total Bent width parallel to river (feet)	Alternative Total Bent width parallel to River (feet)
Bent 1	10	3	3	30	Bent 8	8	10	12	12	118 *outside boundaries of the API and excluded from totals
Bent 2	4	7	5	20	Bent 9	4	7	5	20	
Bent 3	4	7	5	20	Bent 10	13	3	3	39	
Bent 4	4	8	6	24	Total:	8		12	12	
Bent 5	8	10	12	12						
Total:	30		31	106						

Assumptions/Sources:  
 \*References the number of shafts or columns that are above the mudline with potential to create an obstruction to flow.  
 \*tables values from the Bridge Replacement Technical Report (Appendix B)  
 \*Assume all footings in West Approach are fully buried in the ground  
 \*Assume all footings in East Approach are fully buried in the ground

### DEIS Long-span Approaches- Cable Stay

#### West Approach

#### East Approach

Support Locations	Number of Shafts or Columns*	Shaft Diameter (feet)	Column Diameter (feet)	Total Bent width parallel to river (feet)	Support Locations	Number of Shafts or Columns*	Shaft Diameter (feet)	Column Diameter (feet)	Total Bent width parallel to river (feet)	Alternative Total Bent width parallel to River (feet)
Bent 1	10	3	3	30	Bent 9	8	8	15	15	158 *outside boundaries of the API and excluded from totals
Bent 2	4	7	5	20	Bent 10	4	10	8	32	
Bent 3	4	7	5	20	Bent 11	4	6	4	16	
Bent 4	4	7	5	20	Bent 12	13	3	3	39	
Bent 5	8	8	6	6	Total:	12		23	47	
Bent 6	8	8	15	15						
Total:	38		39	111						

Assumptions/Sources:  
 \*References the number of shafts or columns that are above the mudline with potential to create an obstruction to flow.  
 \*table values from the MBEAL Long Span Cable Stay Plan Set  
 \*Assume all footings in West Approach are fully buried in the ground  
 \*Assume all footings in East Approach are fully buried in the ground

## Refined Long Span Approaches- Tied Arch

### West Approach

### East Approach

Support Locations	Number of Shafts or Columns*	Shaft Diameter (feet)	Column Diameter (feet)	Total Bent width parallel to river (feet)	Support Locations	Number of Shafts or Columns*	Shaft Diameter (feet)	Column Diameter (feet)	Total Bent width parallel to river (feet)	Alternative Total Bent width parallel to River (feet)
Bent 1	11	3	3	33	Bent 8	2	10	12	12	132
Bent 2	3	7	9	27	Bent 9	4	8	8	32	*outside boundaries of the API and excluded from totals
Bent 3	2	8	10	20	Bent 10	9	4	4	36	
Bent 4	2	10	8	16	Total:	2		12	12	
Bent 5	2	10	12	24						
Total:	20		42	120						

Assumptions/Sources:

\*References the number of shafts or columns that are above the mudline with potential to create an obstruction to flow.

\*tables values from the Bridge Replacement Technical Report (Appendix B)

\*Assume all footings in West Approach are fully buried in the ground

\*Assume all footings in East Approach are fully buried in the ground

## Refined Long Span Approaches- Cable Stay

### West Approach

### East Approach

Support Locations	Number of Shafts or Columns*	Shaft Diameter (feet)	Column Diameter (feet)	Total Bent width parallel to river (feet)	Support Locations	Number of Shafts or Columns*	Shaft Diameter (feet)	Column Diameter (feet)	Total Bent width parallel to river (feet)	Alternative Total Bent width parallel to River (feet)
Bent 1	11	3	3	33	Bent 8	2	10	20	40	146
Bent 2	3	9	7	21	Bent 9	4	6	6	24	*outside boundaries of the API and excluded from totals
Bent 3	2	10	8	16	Bent 10	9	3	3	27	
Bent 4	2	10	8	16	Total:	2		20	40	
Bent 5	2	12	10	20						
Total:	20		36	106						

Assumptions/Sources:

\*References the number of shafts or columns that are above the mudline with potential to create an obstruction to flow.

\*table values from the MBEAL Long Span Cable Stay Plan Set

\*Assume all footings in West Approach are fully buried in the ground

\*Assume all footings in East Approach are fully buried in the ground

## 500 year Floodplain Impacts

### Results Summary

	West			East			Alternative Total Bent width parallel to River (feet)
	Number of Shafts or Columns*	Total Width of Bents (ft)	Total Bent width parallel to river (feet)	Number of Shafts or Columns*	Total Width of Bents (ft)	Total Bent width parallel to river (feet)	
Alternative							
Existing	72	45	180	26	23	61	241
DEIS Long Span- Tied Arch	30	31	106	8	12	12	118
DEIS Long Span- Cable Stay	38	39	111	12	23	47	158
Refined Long Span- Tied Arch	20	42	120	2	12	12	132
Refined Long Span- Cable Stay	20	36	106	2	20	40	146

\*References the number of shafts or columns that are above the mudline with potential to create an obstruction to flow.

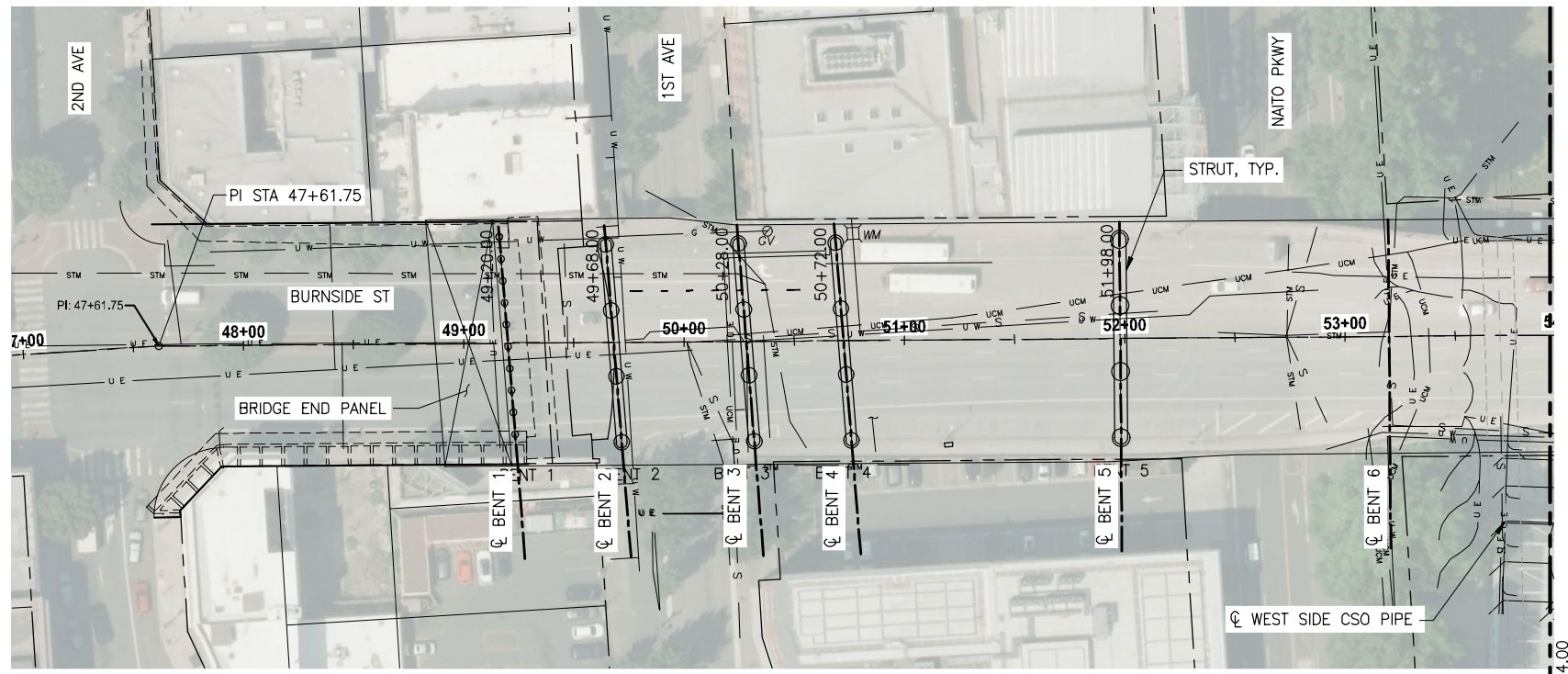

**PLAN**  
SCALE: 1"=40'

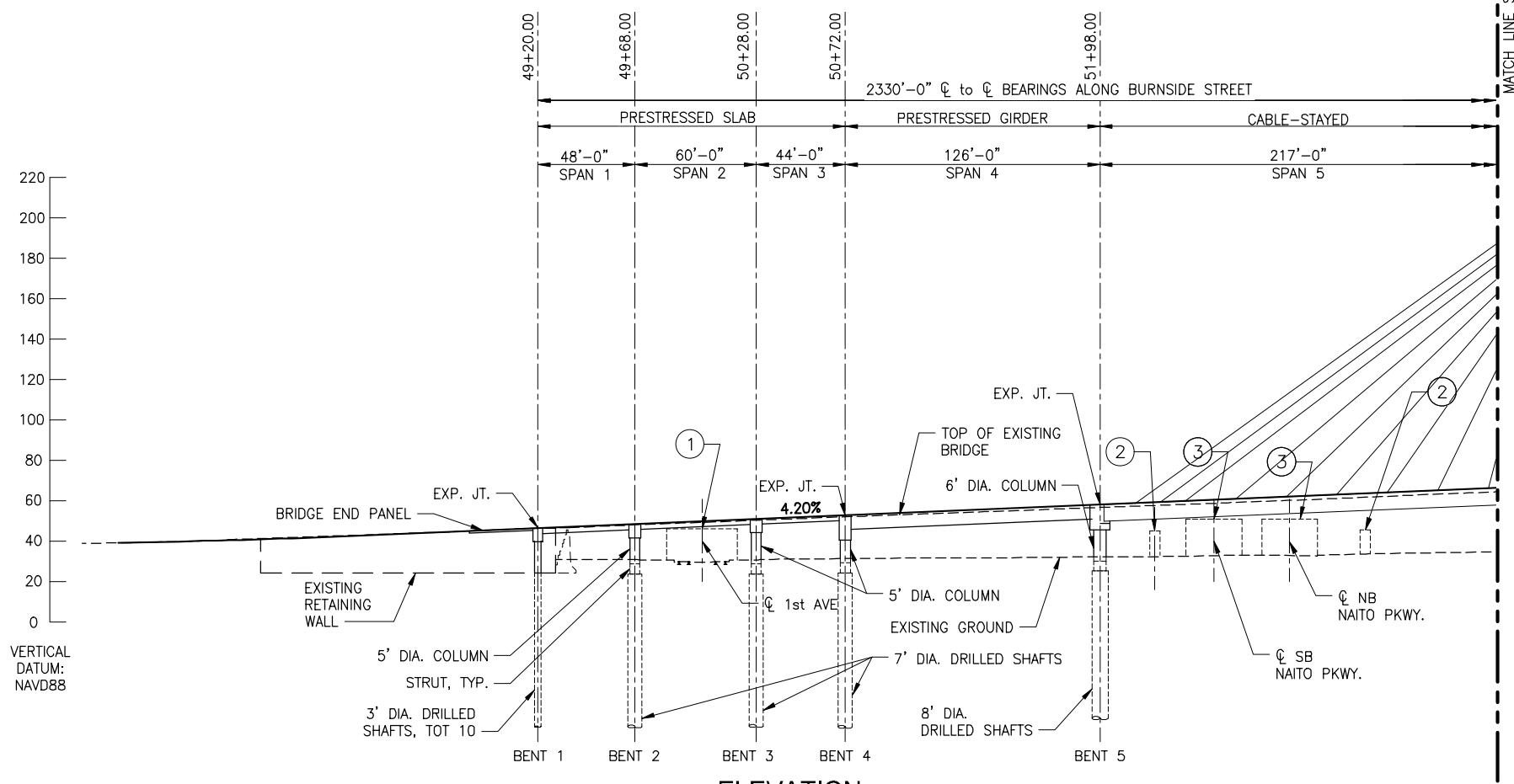

**ELEVATION**  
SCALE: 1"=40'

**CLEARANCE ENVELOPE LEGEND**

①	LRT	15'-6"
②	PEDESTRIAN	12'-0"
③	CITY STREET	18'-0"
④	NAVIGATION	220'-0" W x UNLIMITED H
⑤	HIGHWAY	17'-4"
⑥	UPRR	23'-6"
⑦	CITY STREET @ 3rd AVE	13'-8"

**CONCEPTUAL PLANS**  
JANUARY 2020

**Earthquake Ready Burnside Bridge**  
Replacement Movable Bridge (Bascule) With Long-Span Cable Approach on Existing Alignment  
MULTNOMAH COUNTY  
PROJECT NO.:

MULTNOMAH COUNTY  
DEPARTMENT OF COMMUNITY SERVICES  
TRANSPORTATION DIVISION  
1620 S.E. 190th AVE. PORTLAND, ORE. 97233-5999  
IAN B. CANNON P.E. COUNTY ENGINEER  
DATE:

DESIGNED BY:	
DRAFTED BY:	
CHECKED BY:	
NO. DATE:	
Sheet No.	<b>BR02</b>

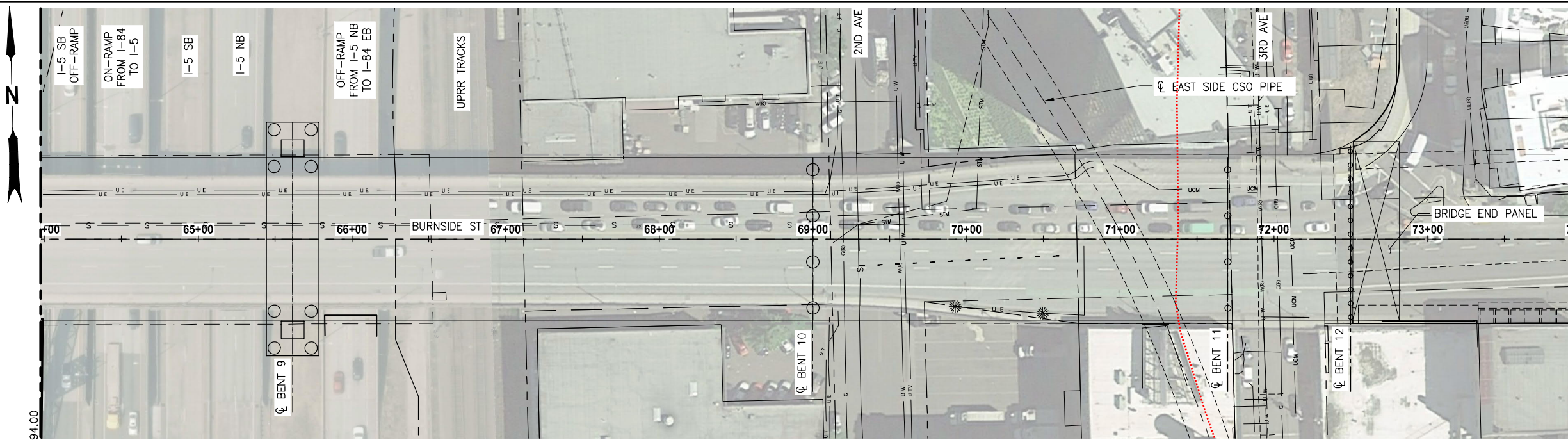

**PLAN**  
SCALE: 1"=40'

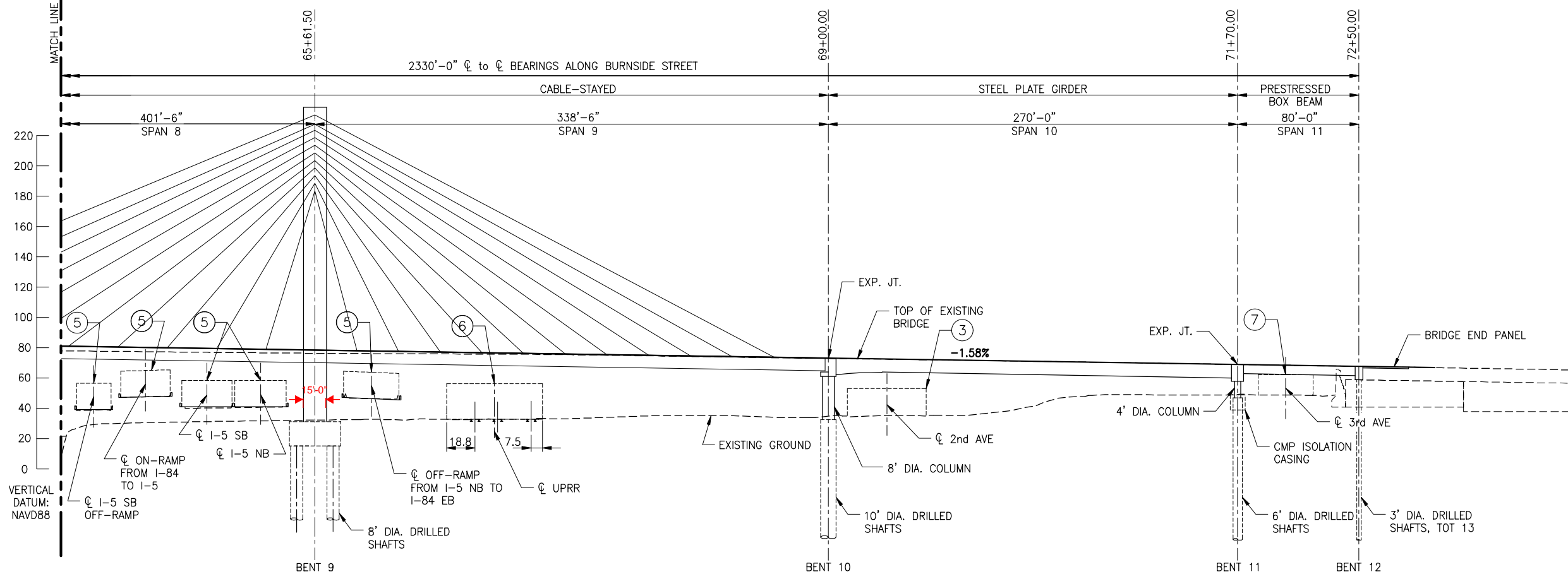

**ELEVATION**  
SCALE: 1"=40'

**CLEARANCE ENVELOPE LEGEND**

①	LRT	15'-6"	⑤	HIGHWAY	17'-4"
②	PEDESTRIAN	12'-0"	⑥	UPRR	23'-6"
③	CITY STREET	18'-0"	⑦	CITY STREET @ 3rd AVE	13'-8"
④	NAVIGATION	220'-0" W x UNLIMITED H			

**CONCEPTUAL PLANS**  
JANUARY 2020

Earthquake Ready Burnside Bridge  
Replacement Movable Bridge (Bascule) With Long-Span Cable Approach on Existing Alignment  
MULTNOMAH COUNTY  
PROJECT NO.:

MULTNOMAH COUNTY  
DEPARTMENT OF COMMUNITY SERVICES  
TRANSPORTATION DIVISION  
1620 S.E. 190th AVE. PORTLAND, ORE. 97233-5999  
IAN B. CANNON P.E.  
COUNTY ENGINEER

DESIGNED BY:  
DRAFTED BY:  
CHECKED BY:

REVISIONS

NO.	DATE:		

Sheet No. **BR04**

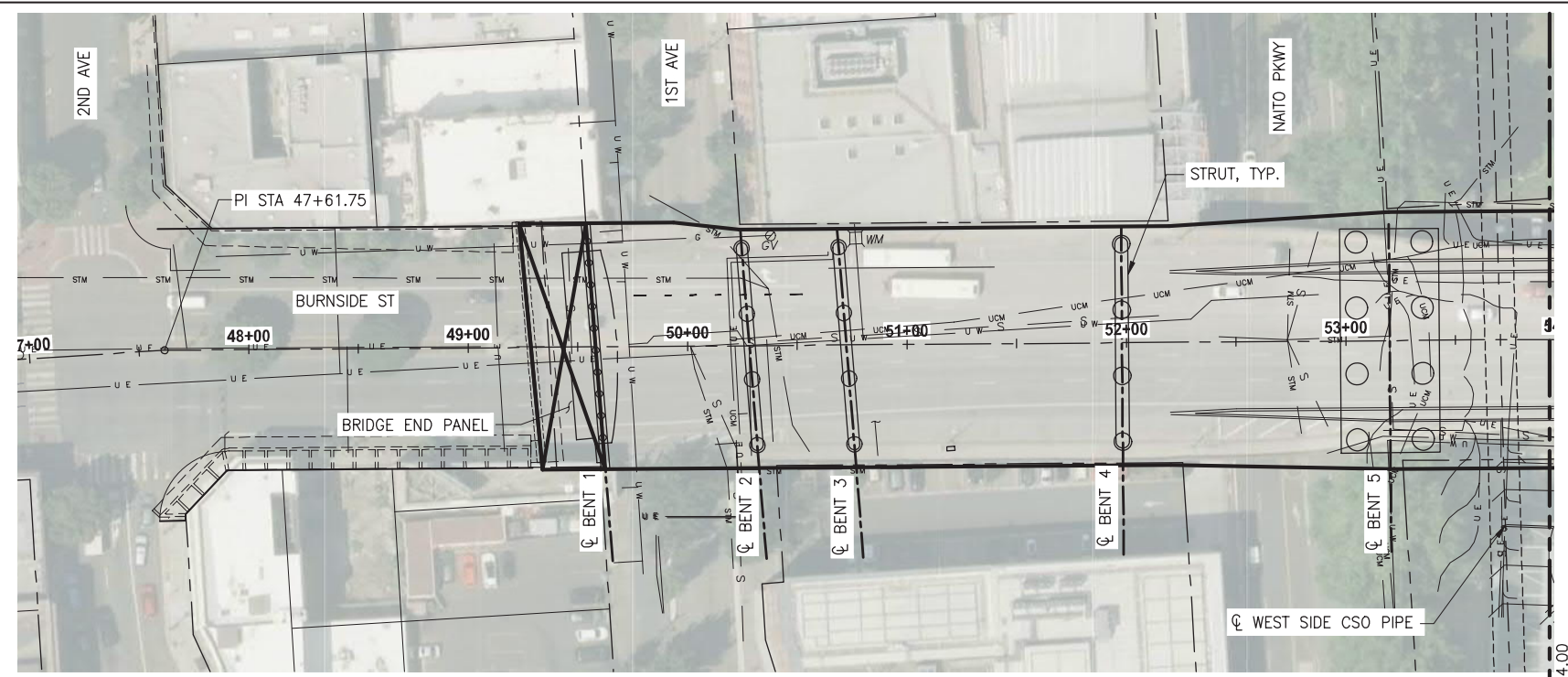

**PLAN**  
SCALE: 1"=40'

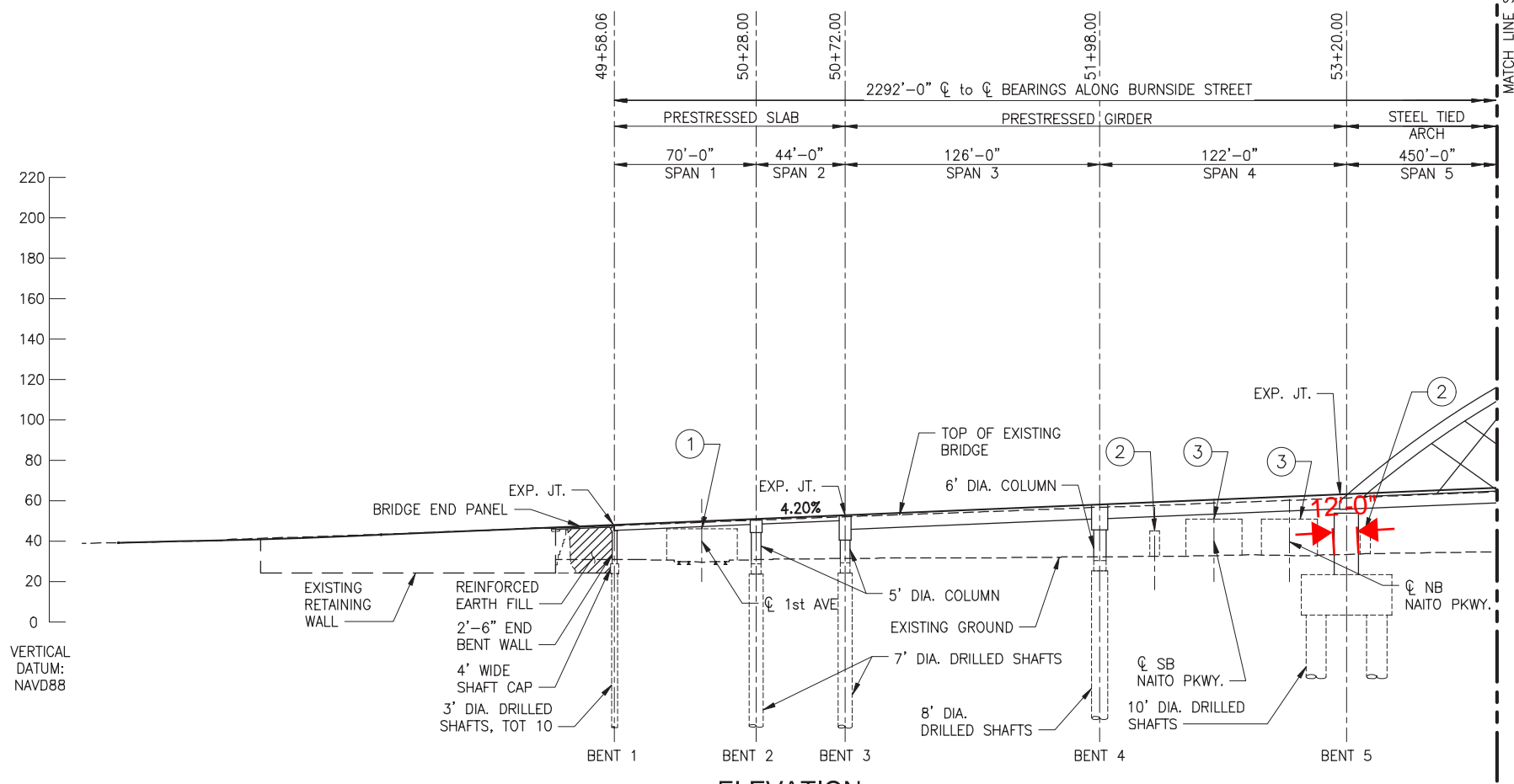

**ELEVATION**  
SCALE: 1"=40'

**CLEARANCE ENVELOPE LEGEND**

①	LRT	15'-6"
②	PEDESTRIAN	12'-0"
③	CITY STREET	18'-0"
④	NAVIGATION	220'-0" W x UNLIMITED H
⑤	HIGHWAY	17'-4"
⑥	UPRR	23'-6"
⑦	CITY STREET @ 3rd AVE	13'-8"

**CONCEPTUAL PLANS**  
JUNE 2020

Earthquake Ready Burnside Bridge  
Replacement Alternative with Long-span Approach (Bascule)  
MULTNOMAH COUNTY  
PROJECT NO.:

MULTNOMAH COUNTY  
DEPARTMENT OF COMMUNITY SERVICES  
TRANSPORTATION DIVISION  
1620 S.E. 190th AVE. PORTLAND, ORE. 97233-9999  
IAN B. CANNON P.E. COUNTY ENGINEER  
DATE:

DESIGNED BY:  
DRAFTED BY:  
CHECKED BY:

**REVISIONS**

NO.	DATE:		

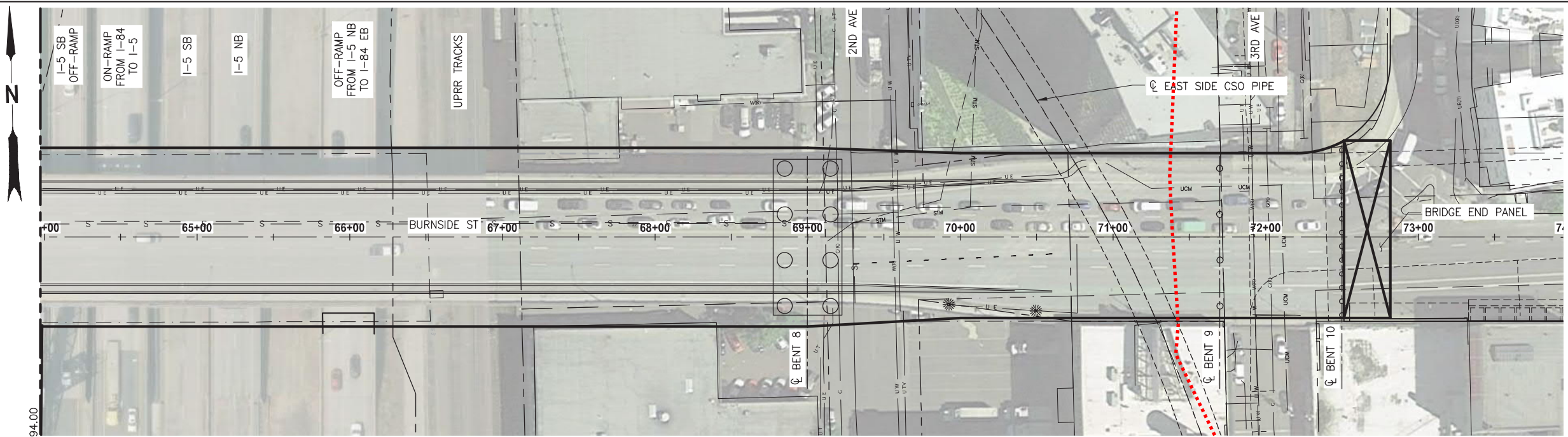

**PLAN**  
SCALE: 1"=40'

Approximate limits of 500 year floodplain

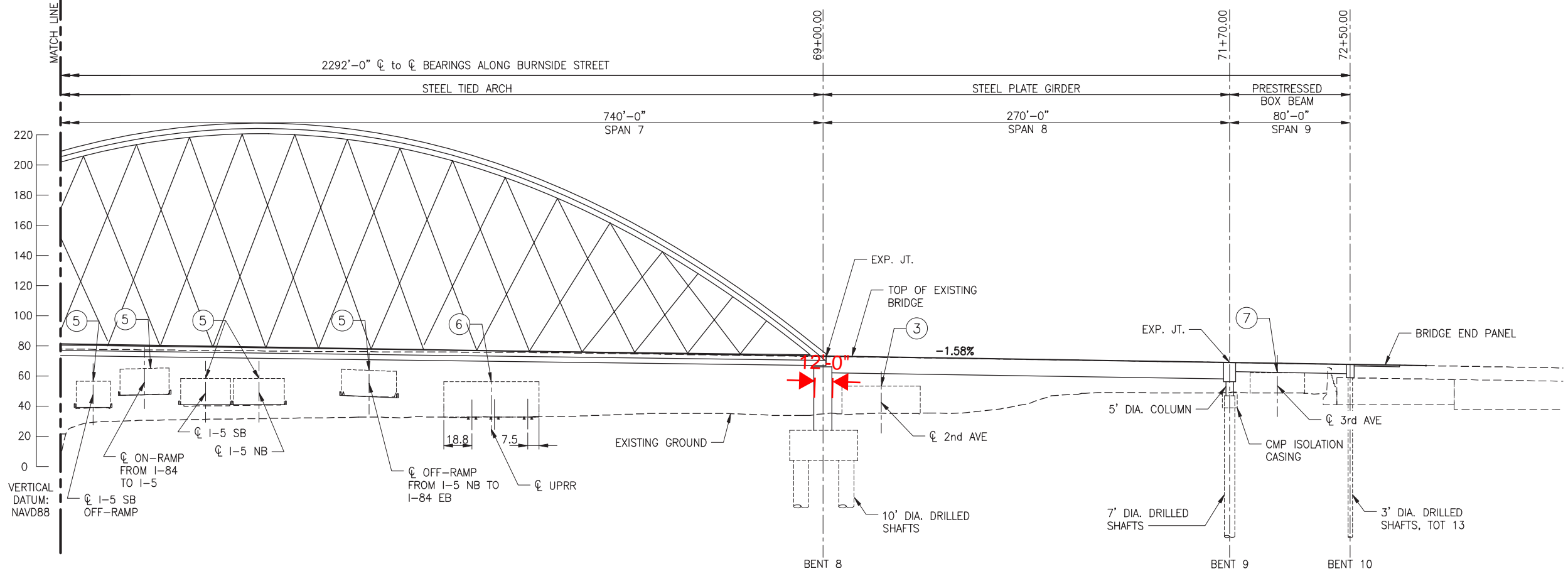

**ELEVATION**  
SCALE: 1"=40'

**CLEARANCE ENVELOPE LEGEND**

①	LRT	15'-6"	⑤	HIGHWAY	17'-4"
②	PEDESTRIAN	12'-0"	⑥	UPRR	23'-6"
③	CITY STREET	18'-0"	⑦	CITY STREET @ 3rd AVE	13'-8"
④	NAVIGATION	220'-0" W x UNLIMITED H			

**CONCEPTUAL PLANS**  
JUNE 2020

Earthquake Ready Burnside Bridge  
Replacement Alternative with Long-span Approach (Bascule)  
MULTNOMAH COUNTY

MULTNOMAH COUNTY  
DEPARTMENT OF COMMUNITY SERVICES  
TRANSPORTATION DIVISION  
1620 S.E. 190th AVE. PORTLAND, ORE. 97233-5999

IAN B. CANNON P.E. COUNTY ENGINEER

DESIGNED BY:  
DRAFTED BY:  
CHECKED BY:

REVISIONS

NO.	DATE:		

Sheet No. **BR12**



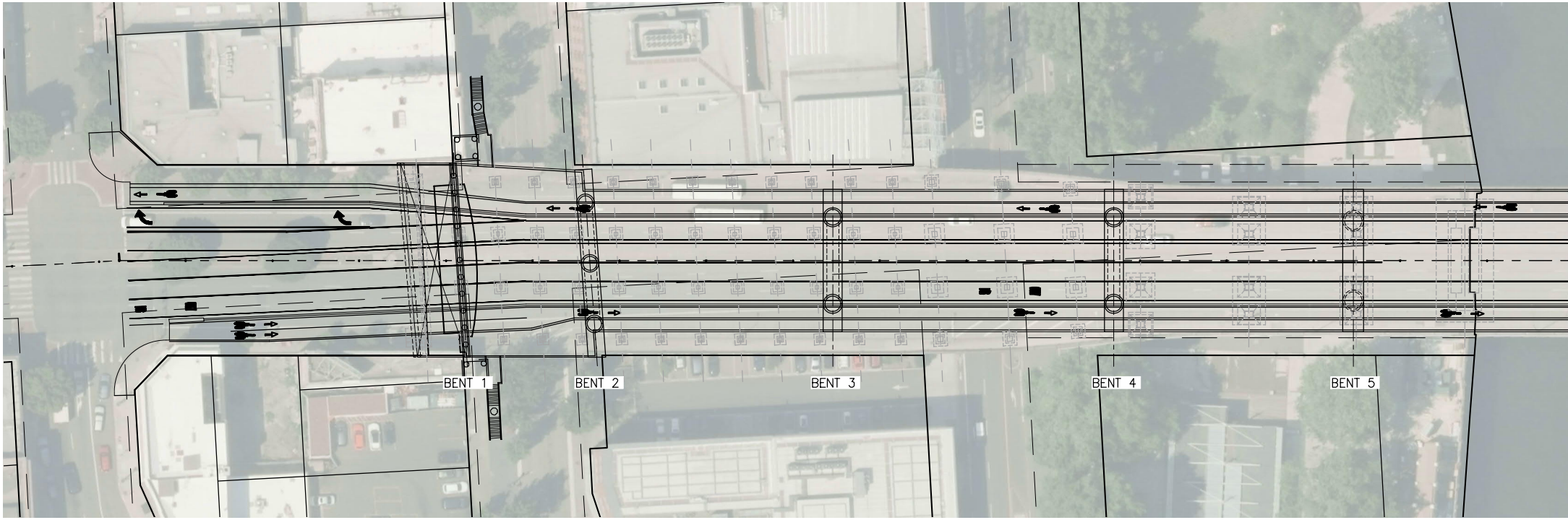

CLEARANCE ENVELOPE LEGEND

- ① LRT 15'-6"
- ② PEDESTRIAN 12'-0"
- ③ CITY STREET 18'-0"
- ④ NAVIGATION 343'-6" W x 147'-0" H
- ⑤ HIGHWAY 17'-4"
- ⑥ UPRR 23'-6"
- ⑦ CITY STREET @ 3RD AVE 13'-8"

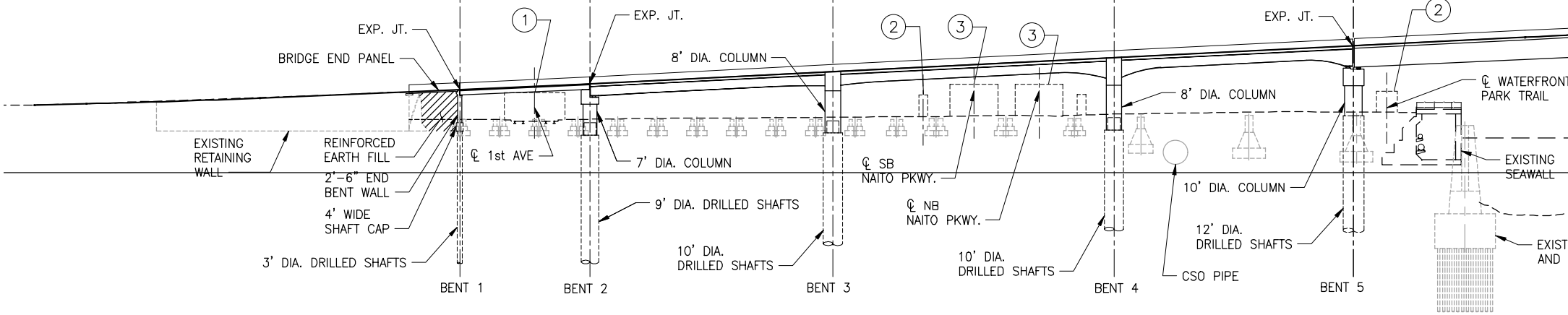
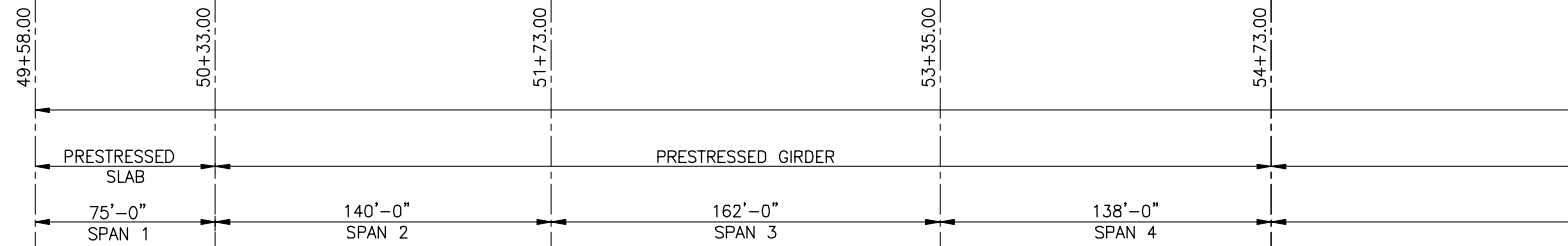

CONCEPTUAL PLANS  
JULY 2021

(Roll Plot - Left/West)

Earthquake Ready Burnside Bridge  
Exhibit  
MULTNOMAH COUNTY  
DATE: 07/2021 PROJECT NO.:

MULTNOMAH COUNTY  
DEPARTMENT OF COMMUNITY SERVICES  
TRANSPORTATION DIVISION  
1620 S.E. 190th AVE. PORTLAND, ORE. 97233-5999

COUNTY ENGINEER

DESIGNED BY: \_\_\_\_\_  
DRAFTED BY: \_\_\_\_\_  
CHECKED BY: \_\_\_\_\_

REVISIONS	
NO.	DATE:

Sheet No. **BR01**



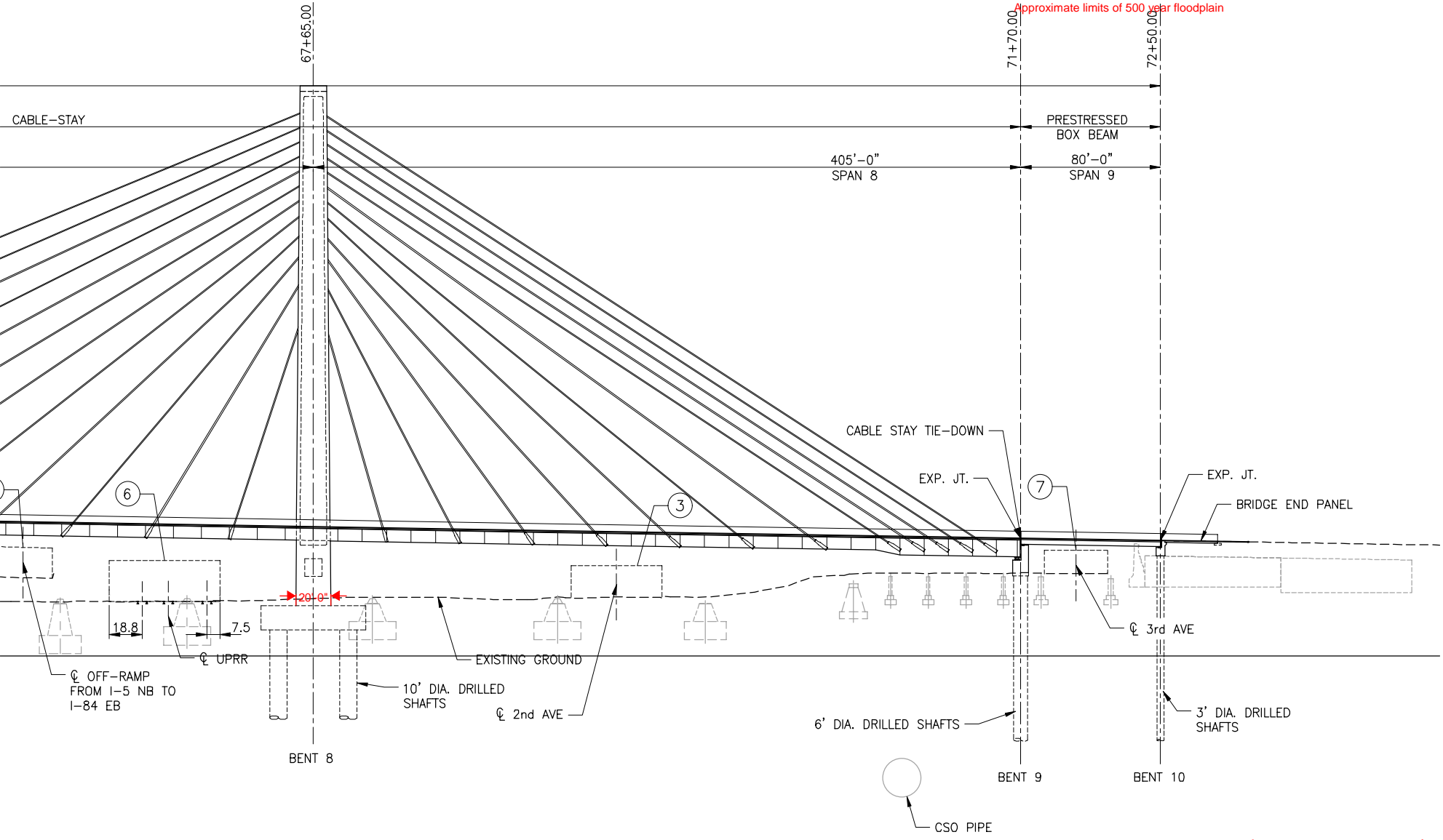
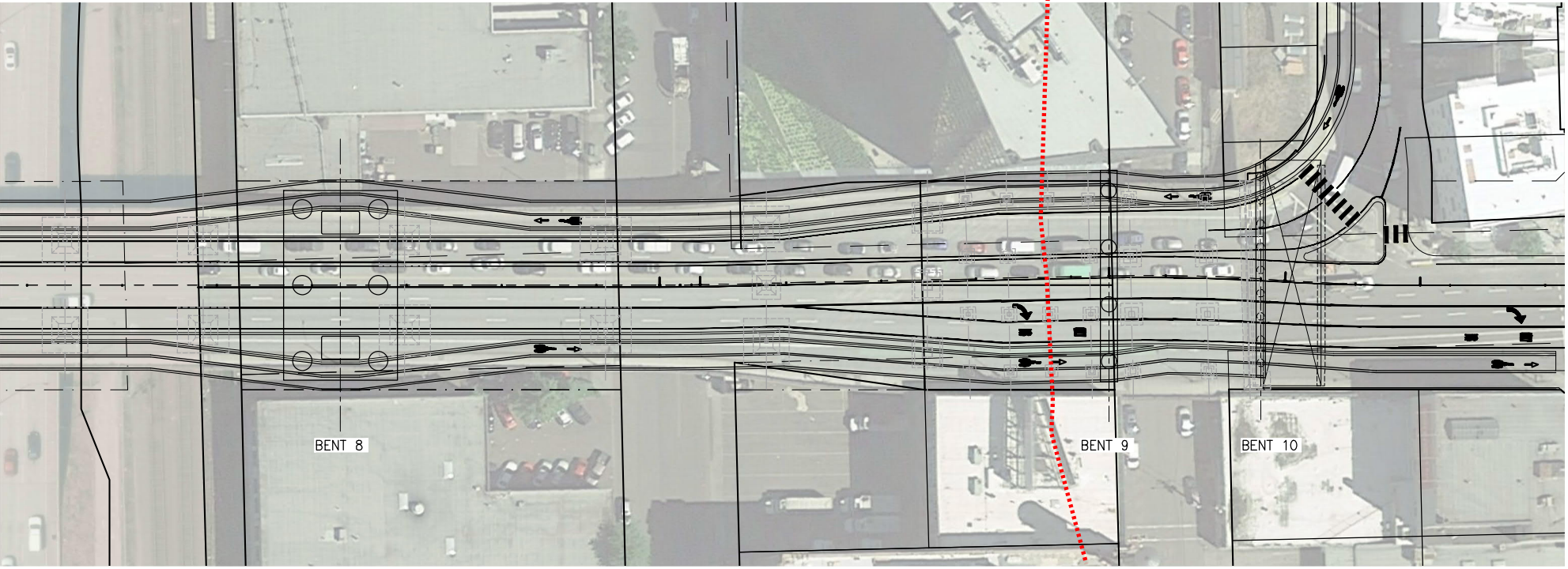

(Roll Plot - Right/East)

<p><b>Earthquake Ready Burnside Bridge</b></p> <p>Exhibit</p>													
<p>MULTNOMAH COUNTY</p> <p>DATE: 07/2021 PROJECT NO.:</p>													
<p><b>MULTNOMAH COUNTY</b>                  DEPARTMENT OF COMMUNITY SERVICES                  TRANSPORTATION DIVISION                  1620 S.E. 190th AVE. PORTLAND, ORE. 97233-5999</p> <p>COUNTY ENGINEER</p>													
DESIGNED BY: _____	CHECKED BY: _____												
DRAFTED BY: _____	_____												
<p>REVISIONS</p> <table border="1" style="width: 100%; border-collapse: collapse;"> <thead> <tr> <th style="width: 10%;">NO.</th> <th style="width: 10%;">DATE:</th> <th style="width: 80%;">REVISIONS</th> </tr> </thead> <tbody> <tr> <td> </td> <td> </td> <td> </td> </tr> <tr> <td> </td> <td> </td> <td> </td> </tr> <tr> <td> </td> <td> </td> <td> </td> </tr> </tbody> </table>		NO.	DATE:	REVISIONS									
NO.	DATE:	REVISIONS											
<p>Sheet No. <b>BR01</b></p>													

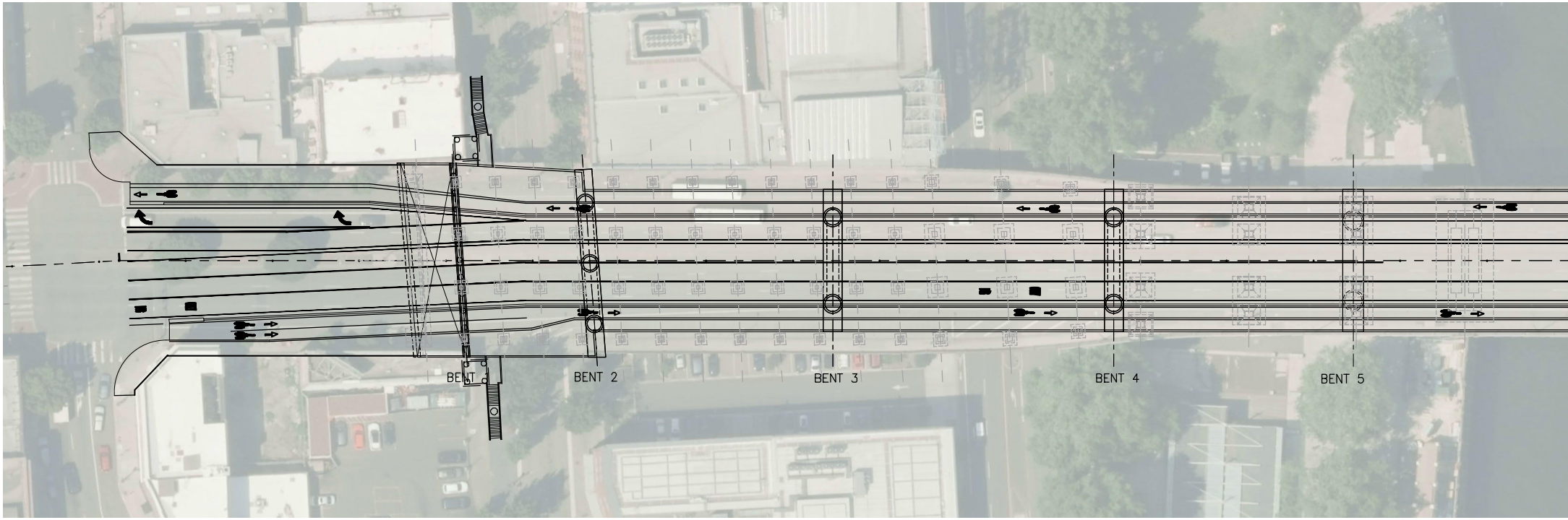

CLEARANCE ENVELOPE LEGEND

- ① LRT 15'-6"
- ② PEDESTRIAN 12'-0"
- ③ CITY STREET 18'-0"
- ④ NAVIGATION 343'-6" W x 147'-0" H
- ⑤ HIGHWAY 17'-4"
- ⑥ UPRR 23'-6"
- ⑦ CITY STREET @ 3RD AVE 13'-8"

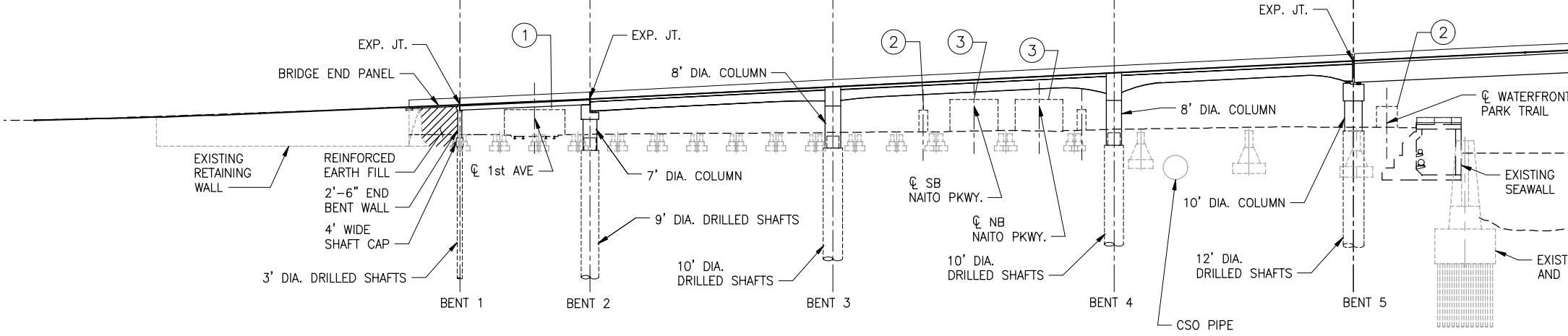
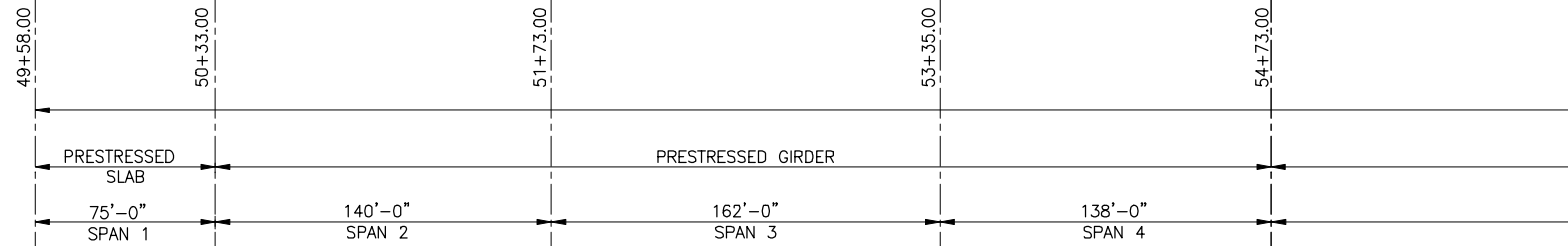

CONCEPTUAL PLANS  
JULY 2021

(Roll Plot - Left/West)

Earthquake Ready Burnside Bridge  
Exhibit  
MULTNOMAH COUNTY  
DATE: 07/2021 PROJECT NO.:

MULTNOMAH COUNTY  
DEPARTMENT OF COMMUNITY SERVICES  
TRANSPORTATION DIVISION  
1620 S.E. 190th AVE. PORTLAND, ORE. 97233-5999

COUNTY ENGINEER

DESIGNED BY: -  
DRAFTED BY: -  
CHECKED BY: -

REVISIONS	
NO.	DATE:

Sheet No. BR01

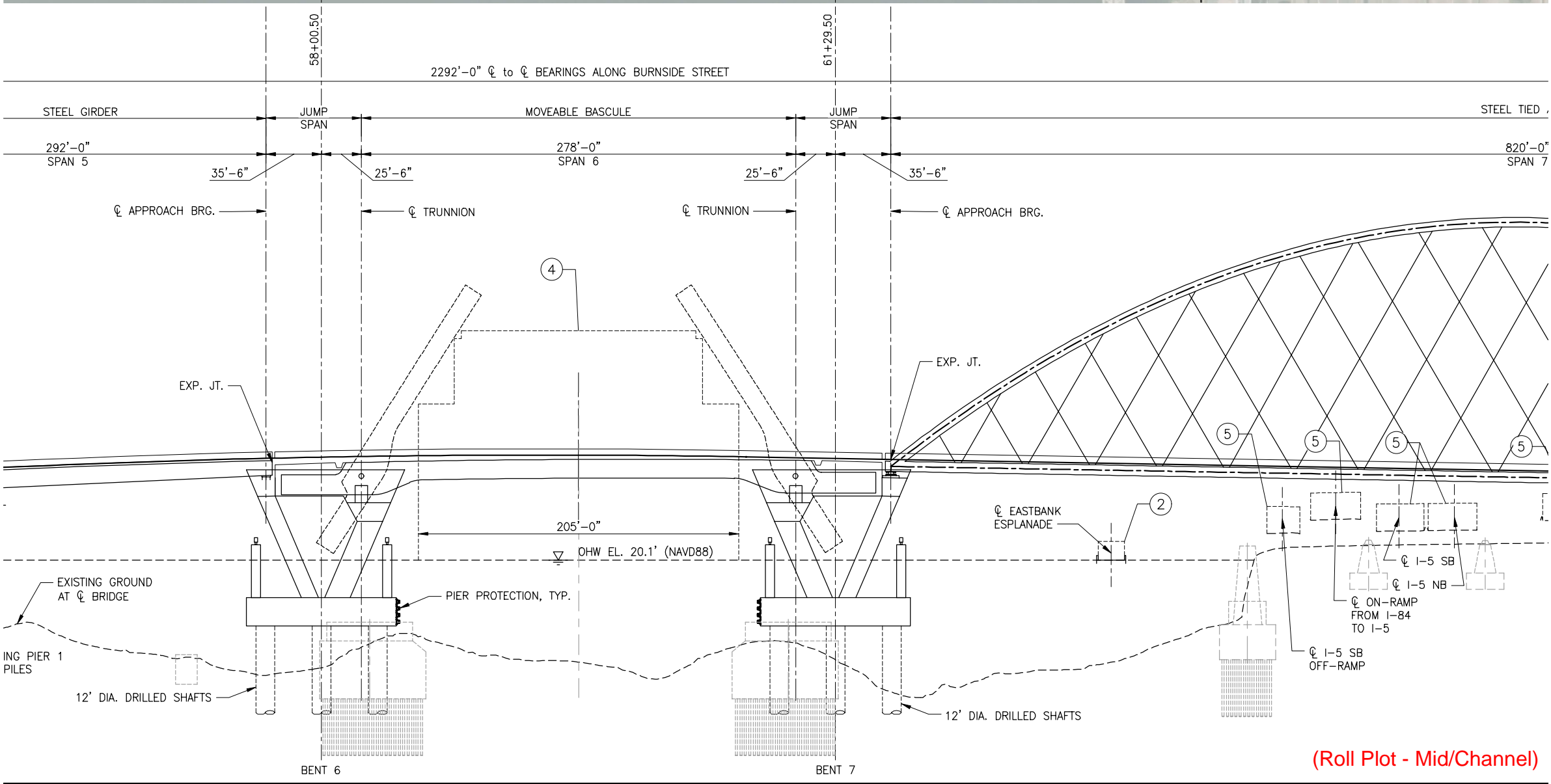
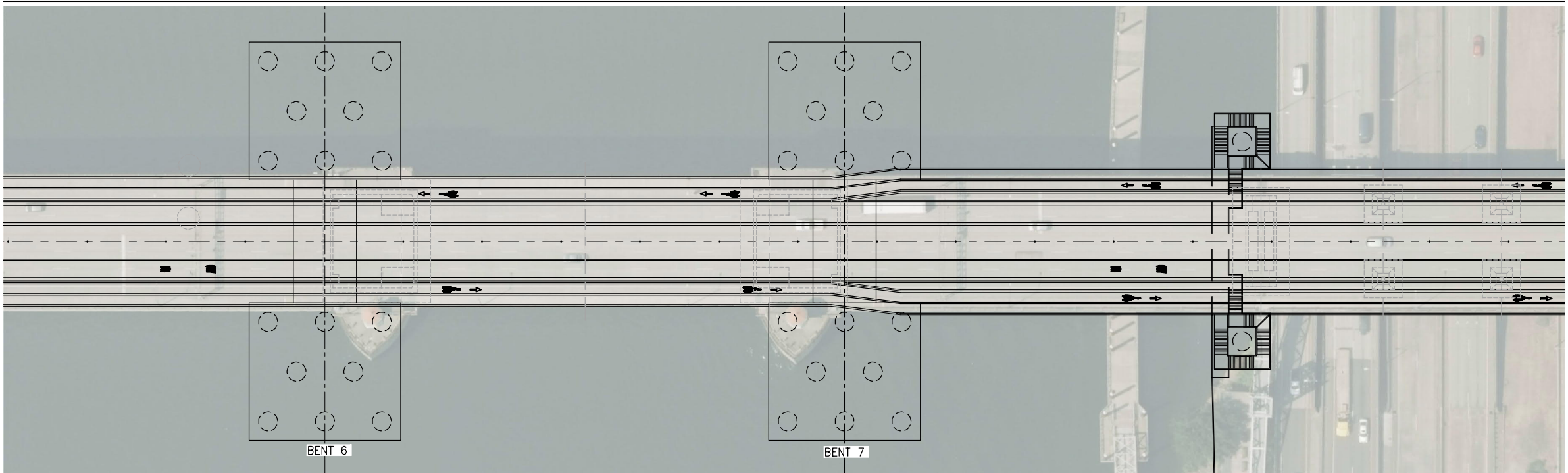

(Roll Plot - Mid/Channel)

Earthquake Ready Burnside Bridge  
 Exhibit  
 MULTNOMAH COUNTY  
 DATE: 07/2021 PROJECT NO.:

MULTNOMAH COUNTY  
 DEPARTMENT OF COMMUNITY SERVICES  
 TRANSPORTATION DIVISION  
 1620 S.E. 190th AVE. PORTLAND, ORE. 97233-5999

COUNTY ENGINEER

DESIGNED BY:	
DRAFTED BY:	
CHECKED BY:	
NO. DATE:	
Sheet No.	B01

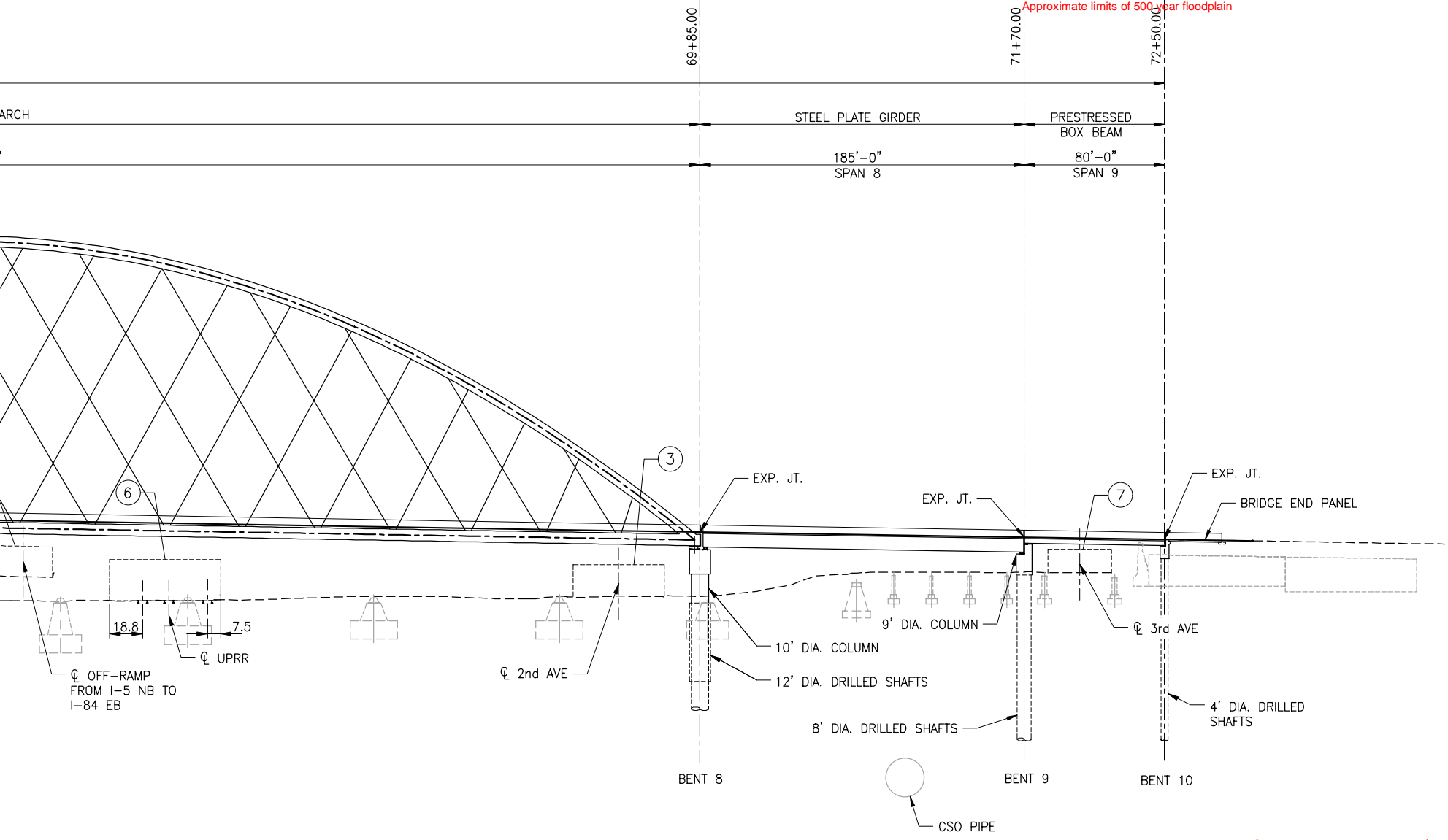
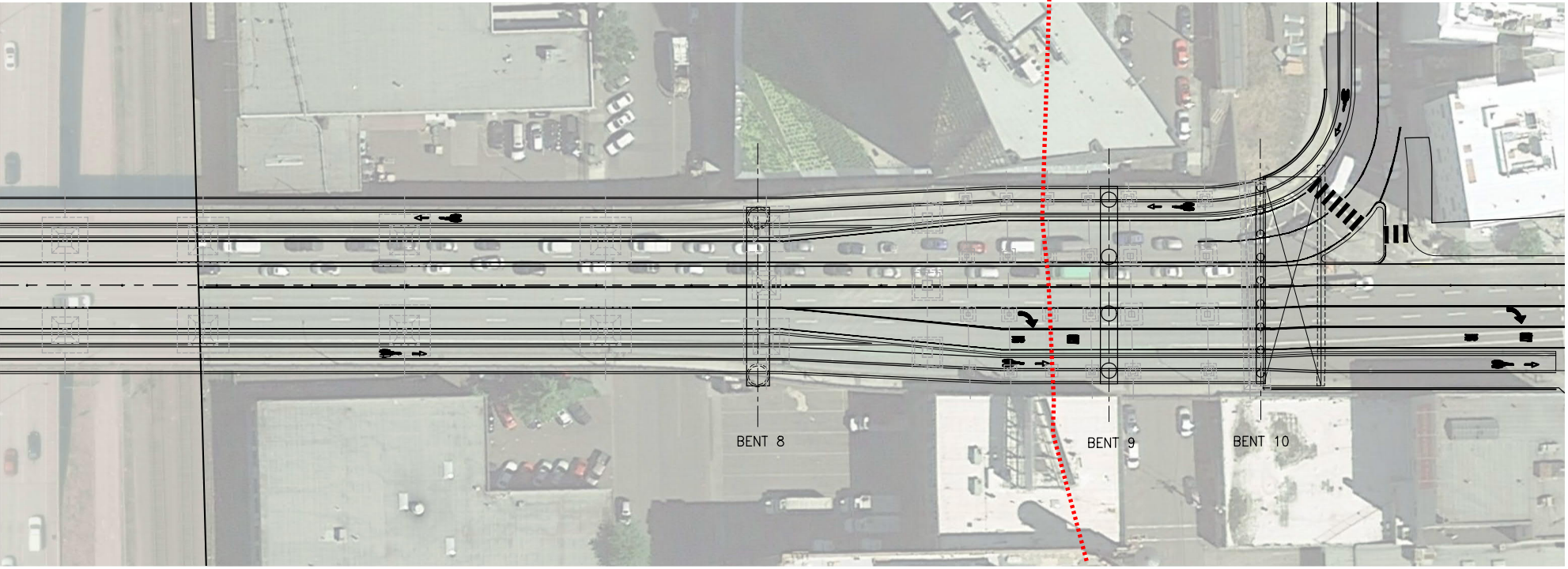

(Roll Plot - Right/East)

<p><b>MULTNOMAH COUNTY</b>          DEPARTMENT OF COMMUNITY SERVICES          TRANSPORTATION DIVISION          1620 S.E. 190th AVE. PORTLAND, ORE. 97233-5999</p>		<p><b>MULTNOMAH COUNTY</b>          COUNTY ENGINEER</p>												
<p><i>Earthquake Ready Burnside Bridge</i></p>		<p><i>Exhibit</i></p>												
<p>DESIGNED BY: _____          DRAFTED BY: _____          CHECKED BY: _____</p>		<p>DATE: <b>07/2021</b> PROJECT NO.:</p>												
<p>REVISIONS</p> <table border="1" style="width: 100%; border-collapse: collapse;"> <thead> <tr> <th style="width: 10%;">NO.</th> <th style="width: 10%;">DATE:</th> <th style="width: 80%;">REVISIONS</th> </tr> </thead> <tbody> <tr> <td> </td> <td> </td> <td> </td> </tr> <tr> <td> </td> <td> </td> <td> </td> </tr> <tr> <td> </td> <td> </td> <td> </td> </tr> </tbody> </table>			NO.	DATE:	REVISIONS									
NO.	DATE:	REVISIONS												
<p>Sheet No. <b>BR01</b></p>														

### Temporary Element Impacts

Alternative	Floodway Cross sectional area (sq. ft)	Work Bridge				
		Total # of piles at cross section of highest impact	width of piles (ft)	Depth of piles (ft)	Total Lateral Surface Area (sq. ft)	Percent of floodway occupied
Existing	65,683	0	2	70	0	0
In Kind (DEIS and Refined Long Spans)	65,683	28	2	70	3,920	6

Assumptions:  
 \*assume all piles have 2 foot diameter  
 \*assume all piles are at 70 foot depth

### Floodway Encroachment associated with Work Bridge Configurations and resulting combinations

Alternative	Floodway Cross sectional area (sq. ft)	Permanent Bridge			Work Bridge		Permanent and Work Bridge Combined Effect %
		Total Lateral Surface Area (sq. ft)	Total Change in LSA (sq. ft.)	Percent of floodway occupied	Total Lateral Surface Area (sq. ft)	Percent of floodway occupied	
Existing	65,683	11,213	0	17	0	0	17
DEIS Long Span-Cable/Bascule	65,683	14,453	3,240	22	3,640	6	28
DEIS Long Span-Arch/Bascule	65,683	14,664	3,451	22	3,640	6	28
DEIS Long Span-Cable/Lift	65,683	10,610	-602	16	3,640	6	22
DEIS Long Span-Arch/Lift	65,683	10,610	-602	16	3,640	6	22
Refined Long Span-Cable/Bascule	65,683	9,480	-1,733	14	3,640	6	20
Refined Long Span-Arch/Bascule	65,683	9,481	-1,732	14	3,640	6	20
Refined Long Span-Cable/Lift	65,683	7,426	-3,787	11	3,780	6	18
Refined Long Span-Arch/Lift	65,683	7,426	-3,787	11	3,780	6	18

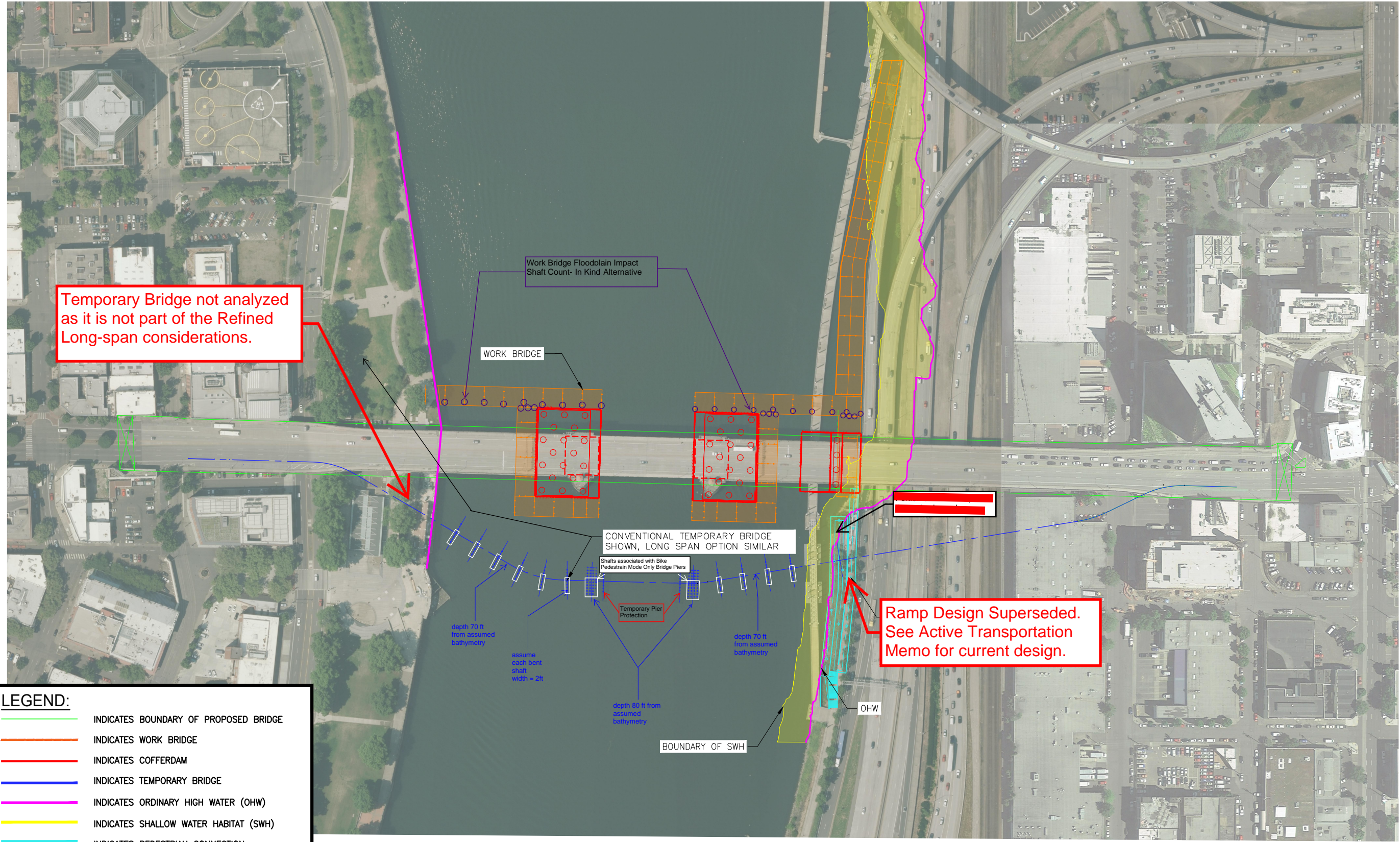

Temporary Bridge not analyzed as it is not part of the Refined Long-span considerations.

Ramp Design Superseded. See Active Transportation Memo for current design.

**LEGEND:**

- INDICATES BOUNDARY OF PROPOSED BRIDGE
- INDICATES WORK BRIDGE
- INDICATES COFFERDAM
- INDICATES TEMPORARY BRIDGE
- INDICATES ORDINARY HIGH WATER (OHW)
- INDICATES SHALLOW WATER HABITAT (SWH)
- INDICATES PEDESTRIAN CONNECTION

**CONCEPTUAL PLANS  
FEBRUARY 2020**

		Earthquake Ready Burnside Bridge Environmental Impacts Replacement in Kind MULTNOMAH COUNTY	
IAN B. CANNON P.E. COUNTY ENGINEER		Date _____ Proj No _____	
DESIGNED BY:	DRAFTED BY:	CHECKED BY:	NOT DATE:
REVISIONS			
Sheet No. _____			